

VARIANTE "A" CANCELLATA 1  
VERSION "A" OF GATE 1



ART. N1/1-09  
lamiera spessore mm 4/4 mm thick metal sheet



ART. N1/2-09  
lamiera spessore mm 4/4 mm thick metal sheet

VARIANTE "B" CANCELLATA 1  
VERSION "B" OF GATE 1

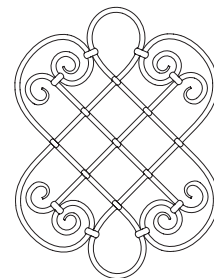

ART. 1606-397  
H. 660 L. 490/H 660, W 490

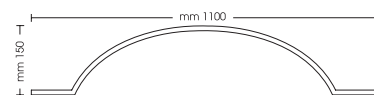

ART. N1/4-09  
+ 30x15 + 25x8

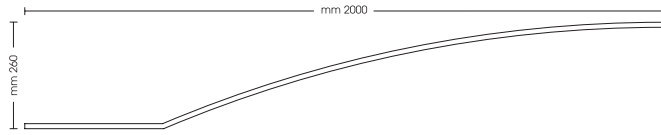

ART. N1/3-09  
# 30x15 # 25x8

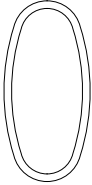
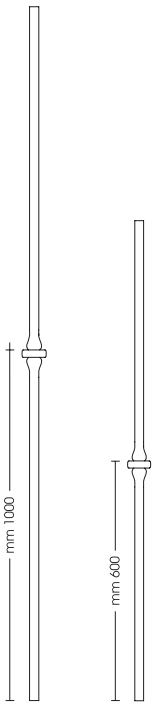

ART. 734/0-231  
H. 260 L. 115/H. 260 W 115  
# 16x6 # 14x6



ART. N1/5-09  
inox AISI 316  
AISI 316 stainless steel

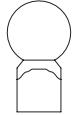

ART. 912/50-191  
ART. 912/40-191



ART. 912/30-191

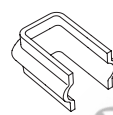

ART. 3500/17-197  
per 1 #14 + 2 #14x6

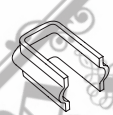

ART. 3500/17-197  
per 1 #16 + 1 #12

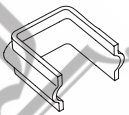

ART. 3500/17-197  
per 1 #16+2#16x6

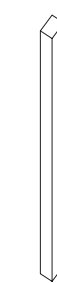
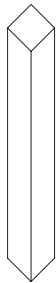

ART. 4500-229  
H. 2000  
#16

ART. 4500-229  
H. 1200  
#14

QUADRO PIENO  
SOLID SQUARE  
#35x35

QUADRO PIENO  
SOLID SQUARE  
#16x16

QUADRO PIENO  
SOLID SQUARE  
#30x30

ANGOLO  
ANGLE  
50x50x6

# 16x8

# 25x8

# 30x8

# 30x15

ART. 929-193

ART. 914/35N-09

ART. 915-192

ART. 916/35-192

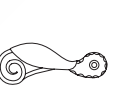

ART. 922/A-193 ART. 922/193 ART. 3035-194

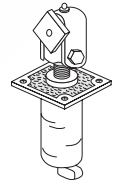

CANCELLATA 2  
GATE 2

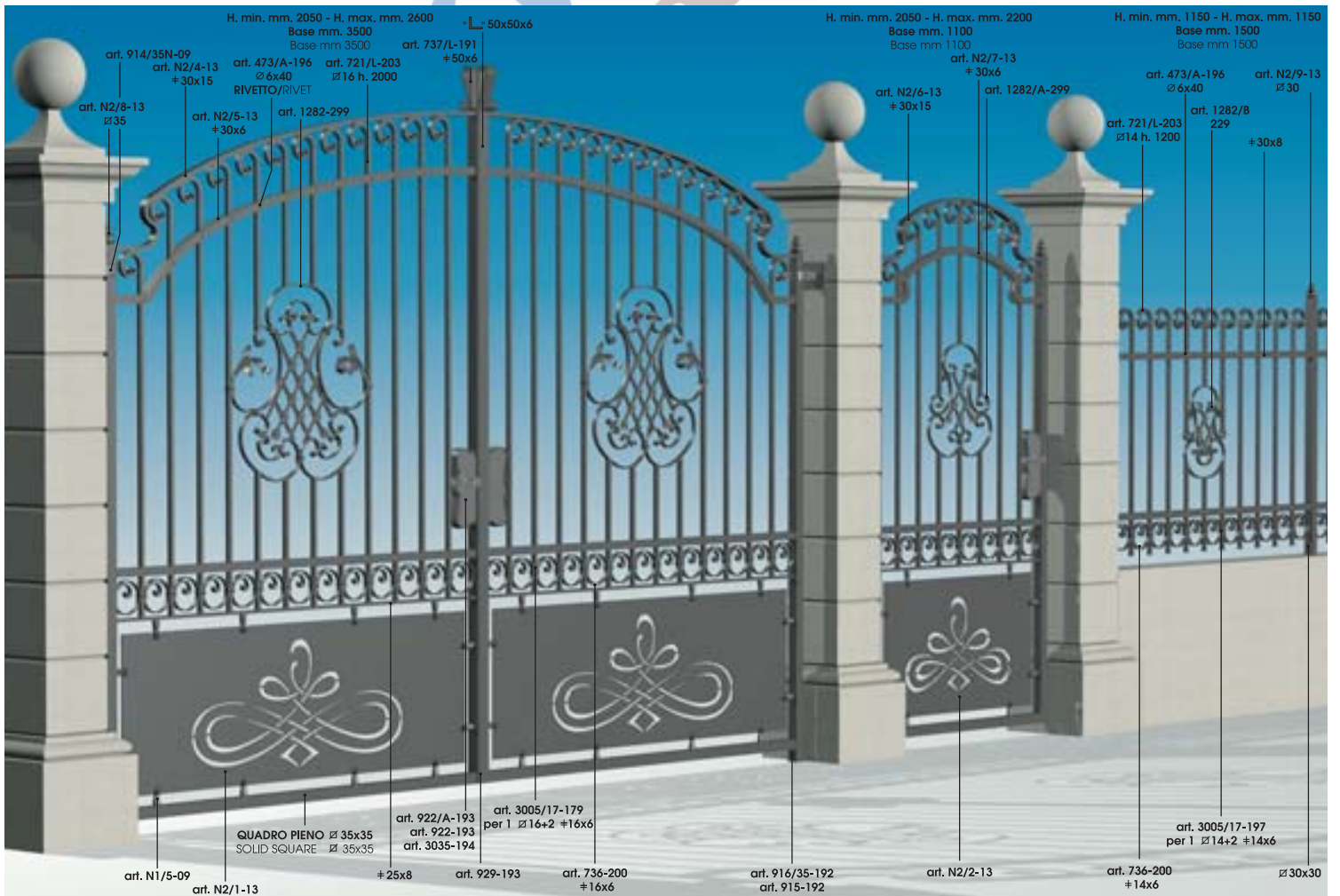

**VARIANTE "A" CANCELLATA 2**  
VERSION "A" OF GATE 2

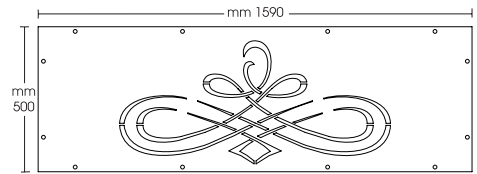

ART. N2/1-13  
lamiera spessore mm 4  
4 mm thick metal sheet

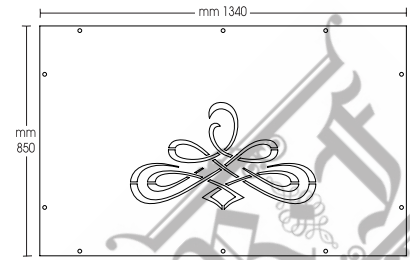

ART. N2/3-13  
lamiera spessore mm 4  
4 mm thick metal sheet

**VARIANTE "B" CANCELLATA 2**  
VERSION "B" OF GATE 2

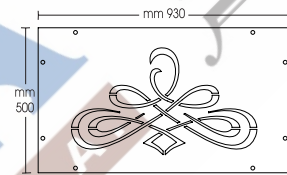

ART. N2/2-13  
lamiera spessore mm 4  
4 mm thick metal sheet

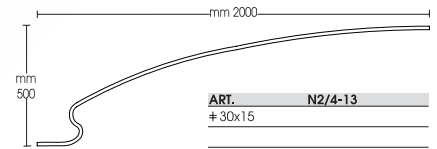

ART. N2/4-13  
# 30x15

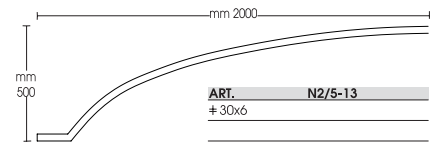

ART. N2/5-13  
# 30x6

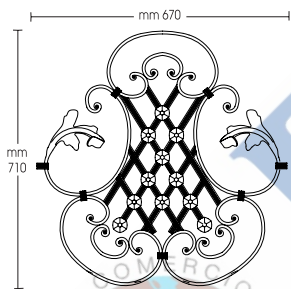

ART. 1282-299

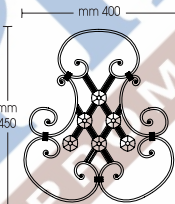

ART. 1282/A-299

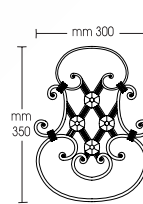

ART. 1282/B-299

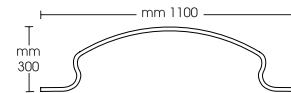

ART. N2/6-13  
# 30x15



ART. 736/200  
Ø 115 # 16x6  
Ø 115 # 14x6

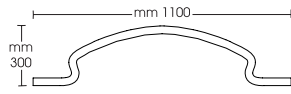

ART. N2/7-13  
# 30x6



ART. 3035-194



ART. 473/A-196  
Ø 35x35



ART. 929-193  
Ø 30x30



ART. 922-193  
# 25x8



ART. 922/A-193  
# 30x8

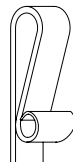

ART. 737/L-191  
# 50x6



ART. N2/9-13  
Ø 30

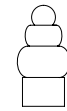

ART. N2/8-13  
Ø 35



ART. 3005/17-197  
per 1 Ø14+2 # 14x6



ART. 3005/17-197  
per 1 Ø16+2 # 16x6

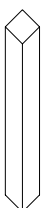

QUADRO PIENO  
SOLID SQUARE  
Ø 35x35

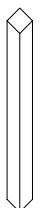

QUADRO PIENO  
SOLID SQUARE  
Ø 30x30



ANGOLO  
ANGLE  
50x50x6



# 25x8



# 30x8



ART. N1/5-09  
inox AISI 316  
AISI 316 stainless steel

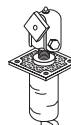

ART. 914/35N-09



ART. 915-192



ART. 916/35-192

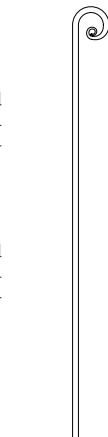

ART. 721/L-203  
H. 2000  
Ø 16



ART. 721/L-203  
H. 1200  
Ø 14

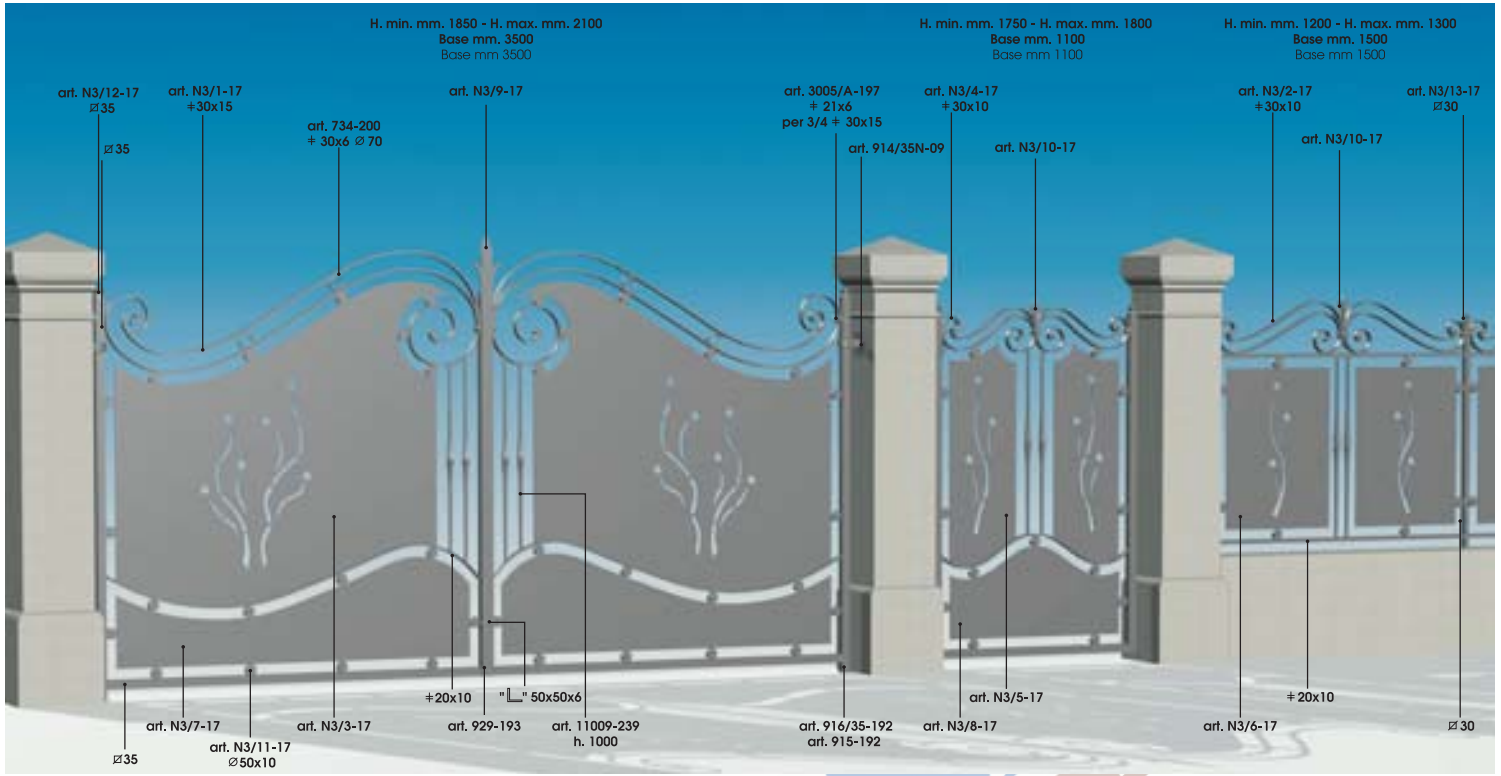

**VARIANTE "A" CANCELLATA 3**  
VERSION "A" OF GATE 3

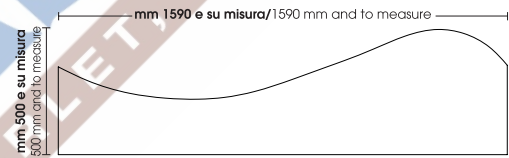

ART. N3/7-17  
lamiera spessore mm 4  
4 mm thick metal sheet

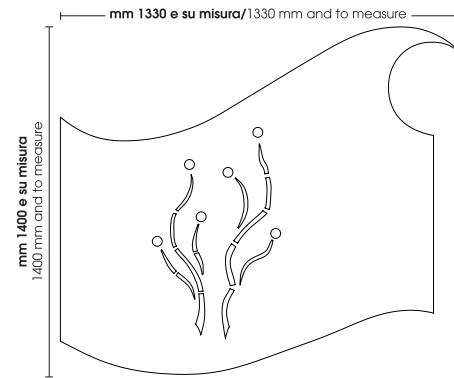

ART. N3/3-17  
lamiera spessore mm 4  
4 mm thick metal sheet

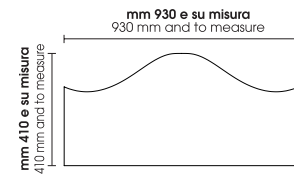

ART. N3/8-17  
lamiera spessore mm 4  
4 mm thick metal sheet

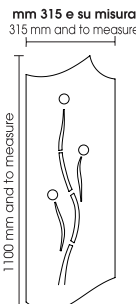

ART. N3/5-17  
lamiera spessore mm 4  
4 mm thick metal sheet

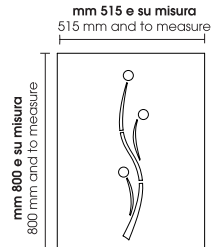

ART. N3/6-17  
lamiera spessore mm 4  
4 mm thick metal sheet

**VARIANTE "B" CANCELLATA 3**  
VERSION "B" OF GATE 3



**COMPONENTI PER CANCELLATA 3**  
ELEMENTS FOR GATE 3

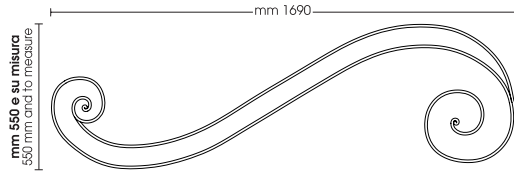

ART. N3/1-17  
# 30x15

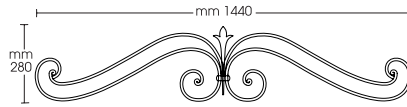

ART. N3/2-17  
# 30x10

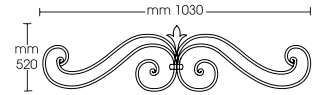

ART. N3/4-17  
# 30x10

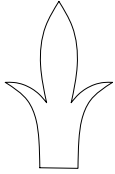

ART. N3/9-17  
spessore mm 8  
thickness 8 mm



ART. N3/10-17  
spessore mm 8  
thickness 8 mm



ART. N3/11-17  
Ø 50x10



ART. N3/12-17  
Ø 35x35



ART. N3/13-17  
Ø 30x30



ART. 922-193



ART. 922/A-193



ART. 3035-194



ART. 11009-239  
H. 1000



ART. QUADRO PIENO  
SOLID SQUARE  
Ø 35x35



ART. QUADRO PIENO  
SOLID SQUARE  
Ø 30x30



ART. ANGOLO  
ANGLE  
50x50x6



ART. # 20x10



ART. 929-193

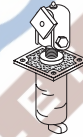

ART. 914/35N-09



ART. 915-192



ART. 916/35-192

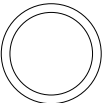

ART. 734-200  
Ø 70  
# 30x6

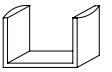

ART. 3005/A-197  
# 21x6 per 3/4 # 30x15

**CANCELLATA 4**  
GATE 4

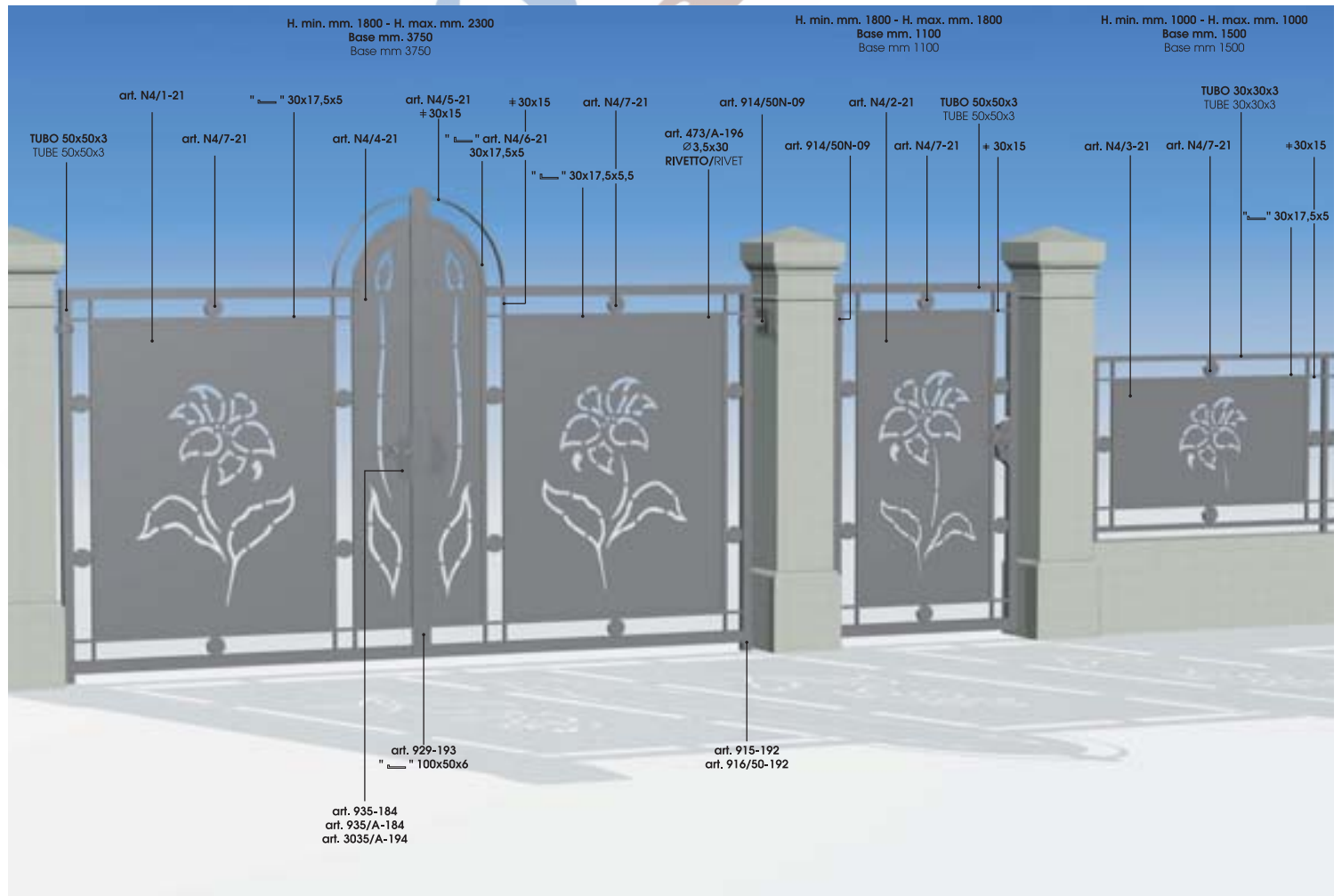

**VARIANTE "A" CANCELLATA 4**  
VERSION "A" OF GATE 4



**VARIANTE "B" CANCELLATA 4**  
VERSION "B" OF GATE 4



**COMPONENTI PER CANCELLATA 4**  
ELEMENTS FOR GATE 4

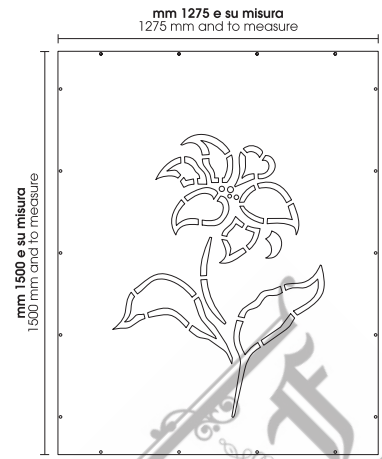

ART. N4/1-21  
lamiera spessore mm4  
4 mm thick metal sheet

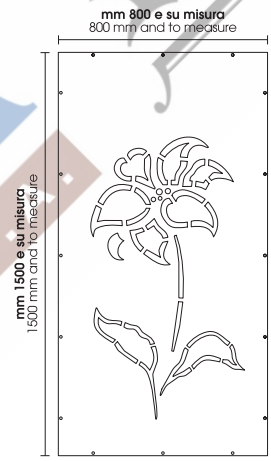

ART. N4/2-21  
lamiera spessore mm4  
4 mm thick metal sheet

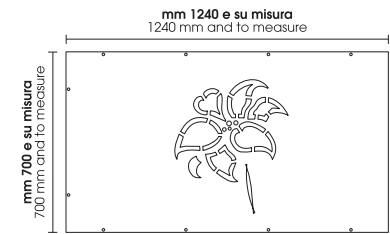

ART. N4/3-21  
lamiera spessore mm4  
4 mm thick metal sheet

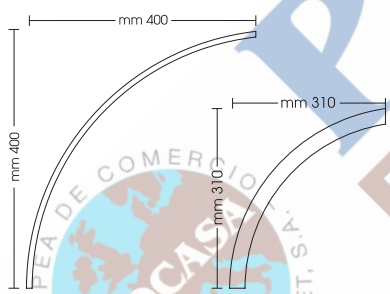

ART. N4/5-21  
# 30x15  
ART. N4/6-21  
30x17,5x5

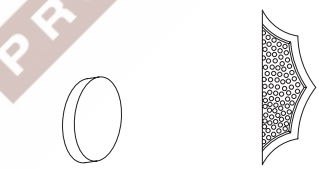

ART. N4/7-21  
Ø mm 90x17  
spessore mm 20  
thickness 20 mm

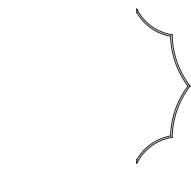

ART. 935-184  
ART. 935/A-184

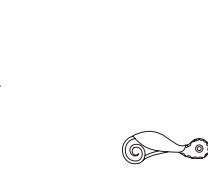

ART. 3035/A-194



ART. 473/A-196  
Ø 3,5x30  
RIVETTO  
RIVET

mm 300 e su misura  
300 mm and to measure

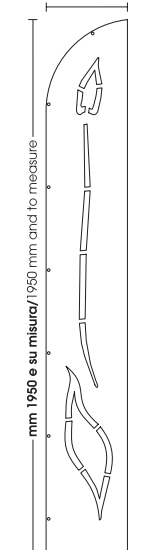

ART. N4/4-21  
lamiera spessore mm4  
4 mm thick metal sheet

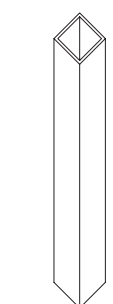

TUBO  
50x50x3



TUBO  
30x30x3



30x17,5x5,5

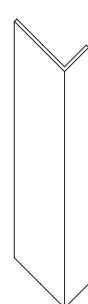

100x50x6



# 30x15



ART. 929-193

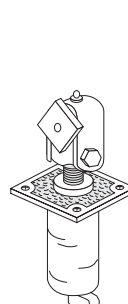

ART. 914/50N-09

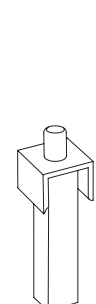

ART. 915-192



ART. 916/50-192

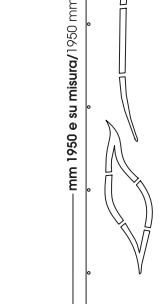

ART. N4/4-21  
lamiera spessore mm4  
4 mm thick metal sheet

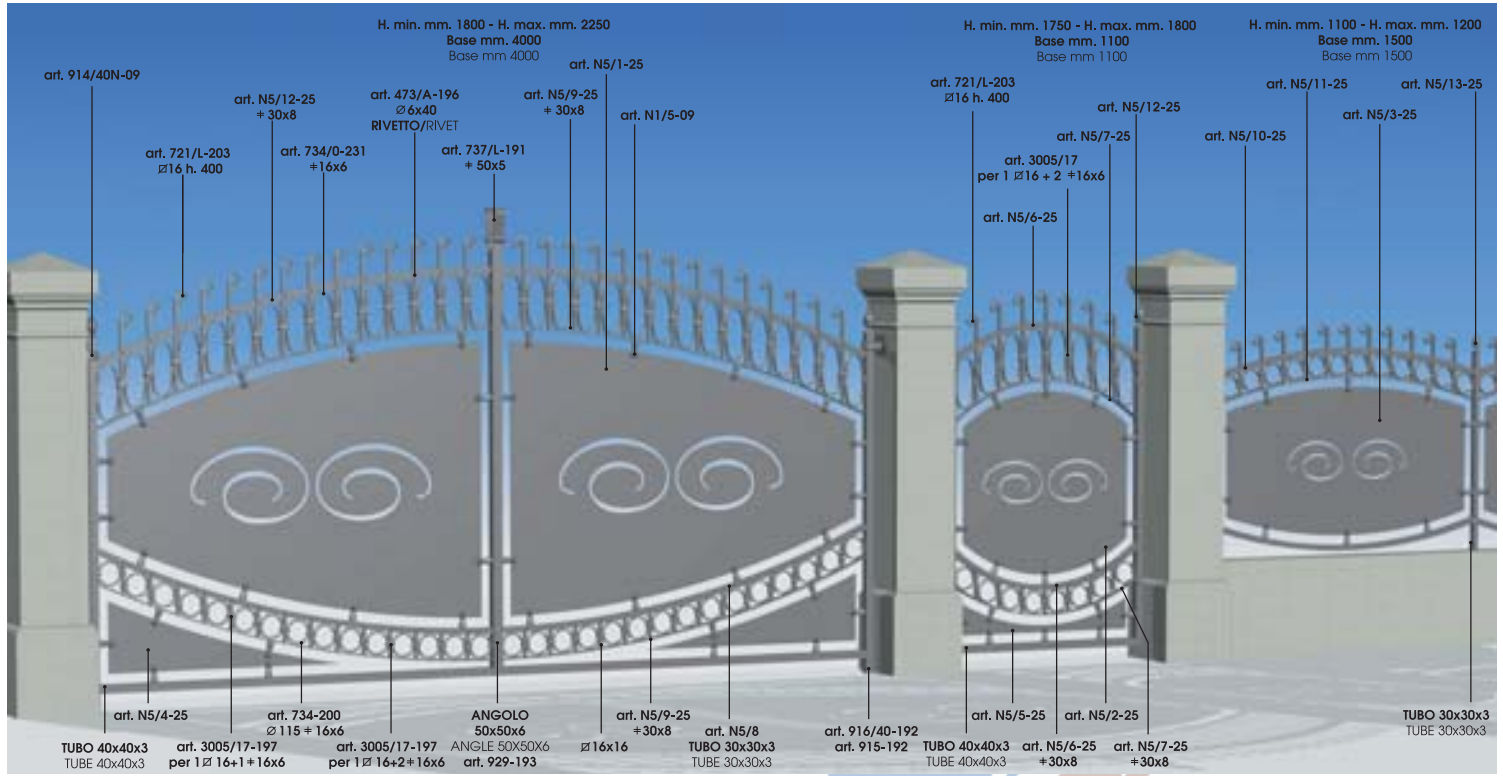

**VARIANTE "A" CANCELLATA 5**  
VERSION "A" OF GATE 5

**COMPONENTI PER CANCELLATA 5**  
ELEMENTS FOR GATE 5

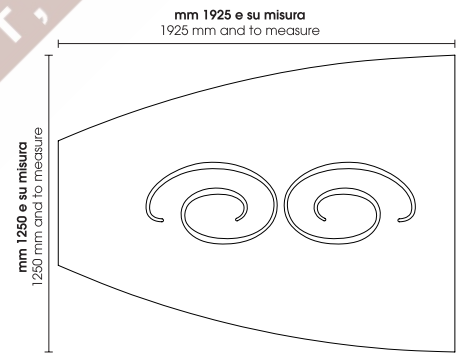

**ART. N5/1-25**  
lamiera spessore mm 4  
4 mm thick metal sheet

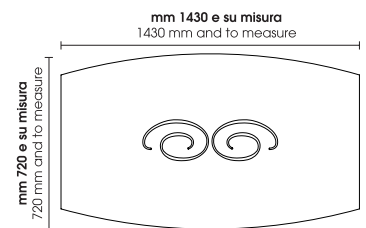

**ART. N5/3-25**  
lamiera spessore mm 4  
4 mm thick metal sheet

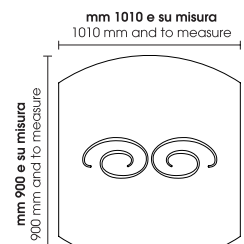

**ART. N5/2-25**  
lamiera spessore mm 4  
4 mm thick metal sheet

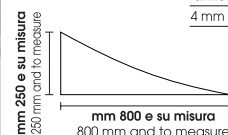

**ART. N5/4-25**  
lamiera spessore mm 4  
4 mm thick metal sheet

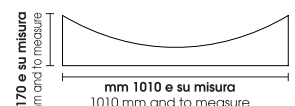

**ART. N5/5-25**  
lamiera spessore mm 4  
4 mm thick metal sheet

**VARIANTE "B" CANCELLATA 5**  
VERSION "B" OF GATE 5



**COMPONENTI PER CANCELLATA 5**  
ELEMENTS FOR GATE 5

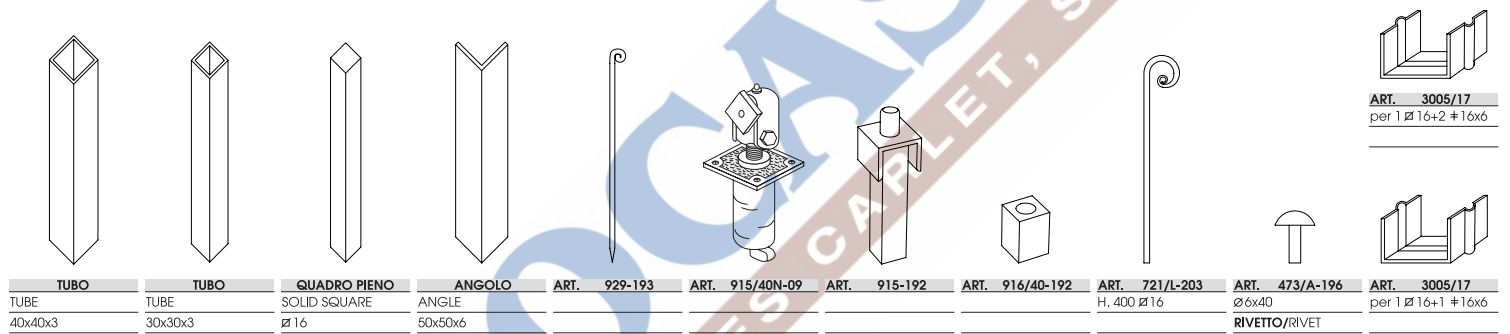
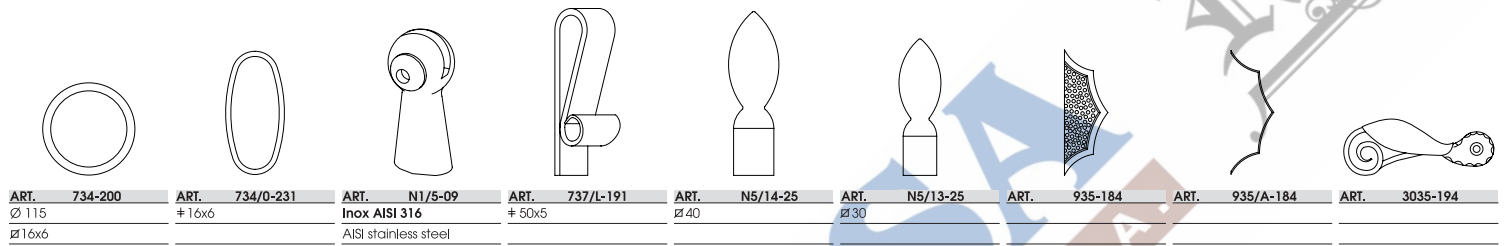
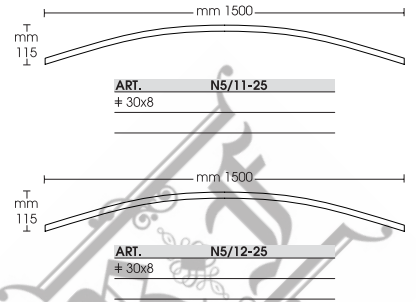
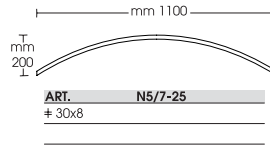
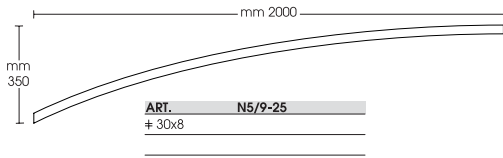
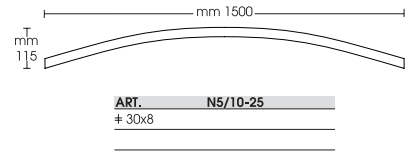
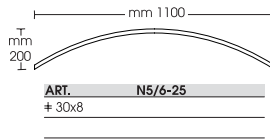
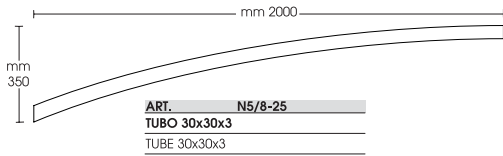

**CANCELLATA 6**  
GATE 6

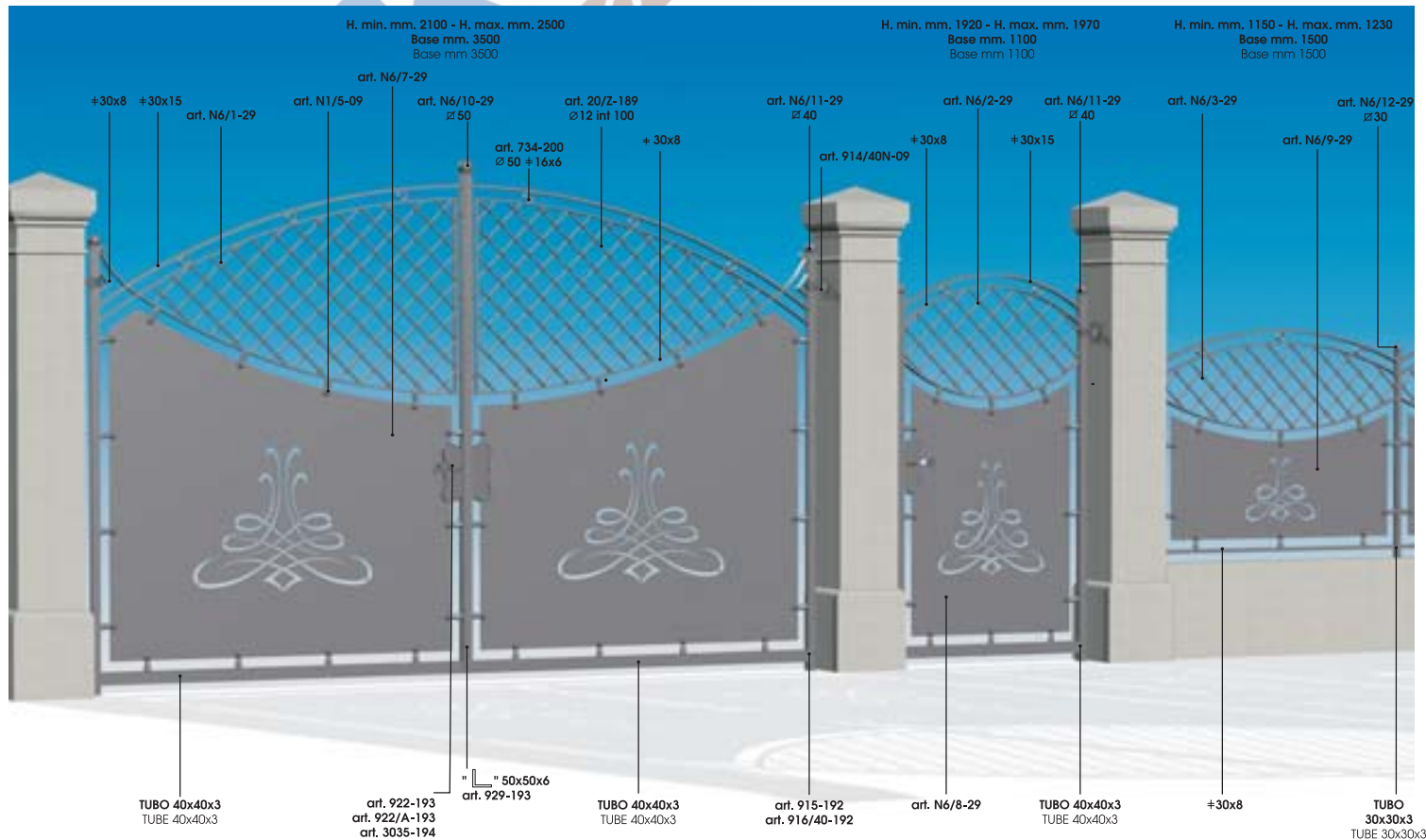



**VARIANTE "A" CANCELLATA 6**  
VERSION "A" OF GATE 6

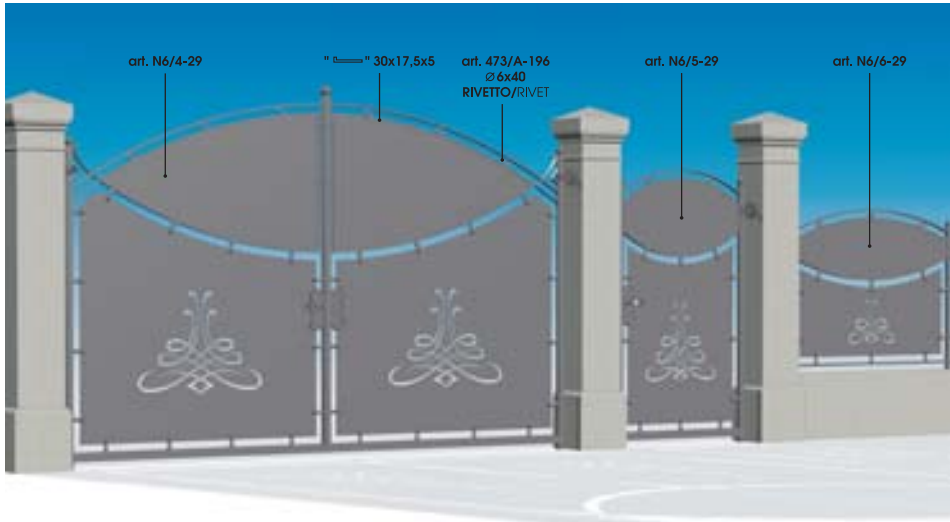

**VARIANTE "B" CANCELLATA 6**  
VERSION "B" OF GATE 6



**COMPONENTI PER CANCELLATA 6**  
ELEMENTS FOR GATE 6

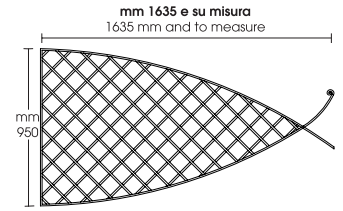

**ART. N6/1-29**  
Barre bucate Ø12 - interasse mm. 100  
perled bars Ø12 - distance between holes 100 mm

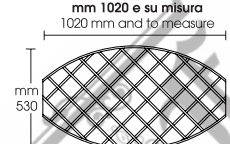

**ART. N6/2-29**  
Barre bucate Ø12 - interasse mm. 100  
perled bars Ø12 - distance between holes 100 mm

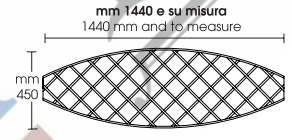

**ART. N6/3-29**  
Barre bucate Ø12 - interasse mm. 100  
perled bars Ø12 - distance between holes 100 mm

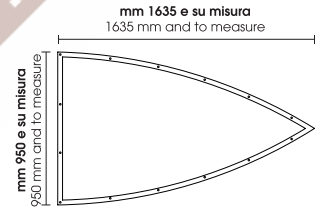

**ART. N6/4-29**  
con angolo 30 x 17,5 x 5,5 lamiera spessore mm 5  
with corner 30 x 17,5 x 5,5 5 mm thick metal sheet

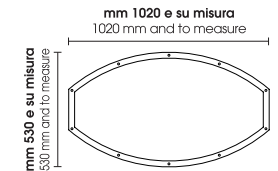

**ART. N6/5-29**  
con angolo 30 x 17,5 x 5,5 lamiera spessore mm 5  
with corner 30 x 17,5 x 5,5 5 mm thick metal sheet

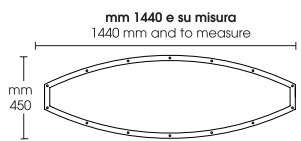

**ART. N6/6-29**  
con angolo 30 x 17,5 x 5,5 lamiera spessore mm 5  
with corner 30 x 17,5 x 5,5 5 mm thick metal sheet

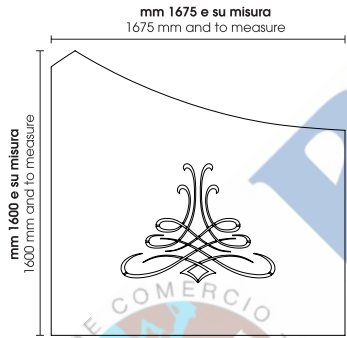

**ART. N6/7-29**  
lamiera spessore mm 4  
4 mm thick metal sheet

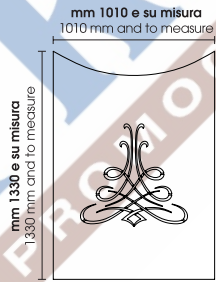

**ART. N6/8-29**  
lamiera spessore mm 4  
4 mm thick metal sheet

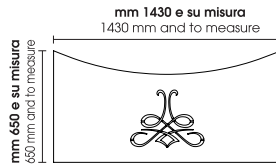

**ART. N6/9-29**  
lamiera spessore mm 4  
4 mm thick metal sheet



ART. N6/10-29 Ø 50x50	ART. N6/11-29 Ø 40x40	ART. N6/12-29 Ø 30x30	ART. N1/5-09 Inox AISI 316 AISI 316 stainless steel	ART. 734-200 Ø 50 ±16x6	ART. 922-193	ART. 922/A-193	ART. 3035-194
--------------------------	--------------------------	--------------------------	---	----------------------------	--------------	----------------	---------------

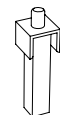
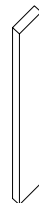

TUBO 40x40x3	TUBO 30x30x3	" " " " " " 30x17,5x5,5	ANGOLO 50x50x6	± 30x8	± 30x15	20/2 Ø 12-189 interasse mm 100 distance between holes mm 100	ART. 922-193	ART. 914/40N-09	ART. 915-192	ART. 916/40-192
-----------------	-----------------	----------------------------	-------------------	--------	---------	--	--------------	-----------------	--------------	-----------------

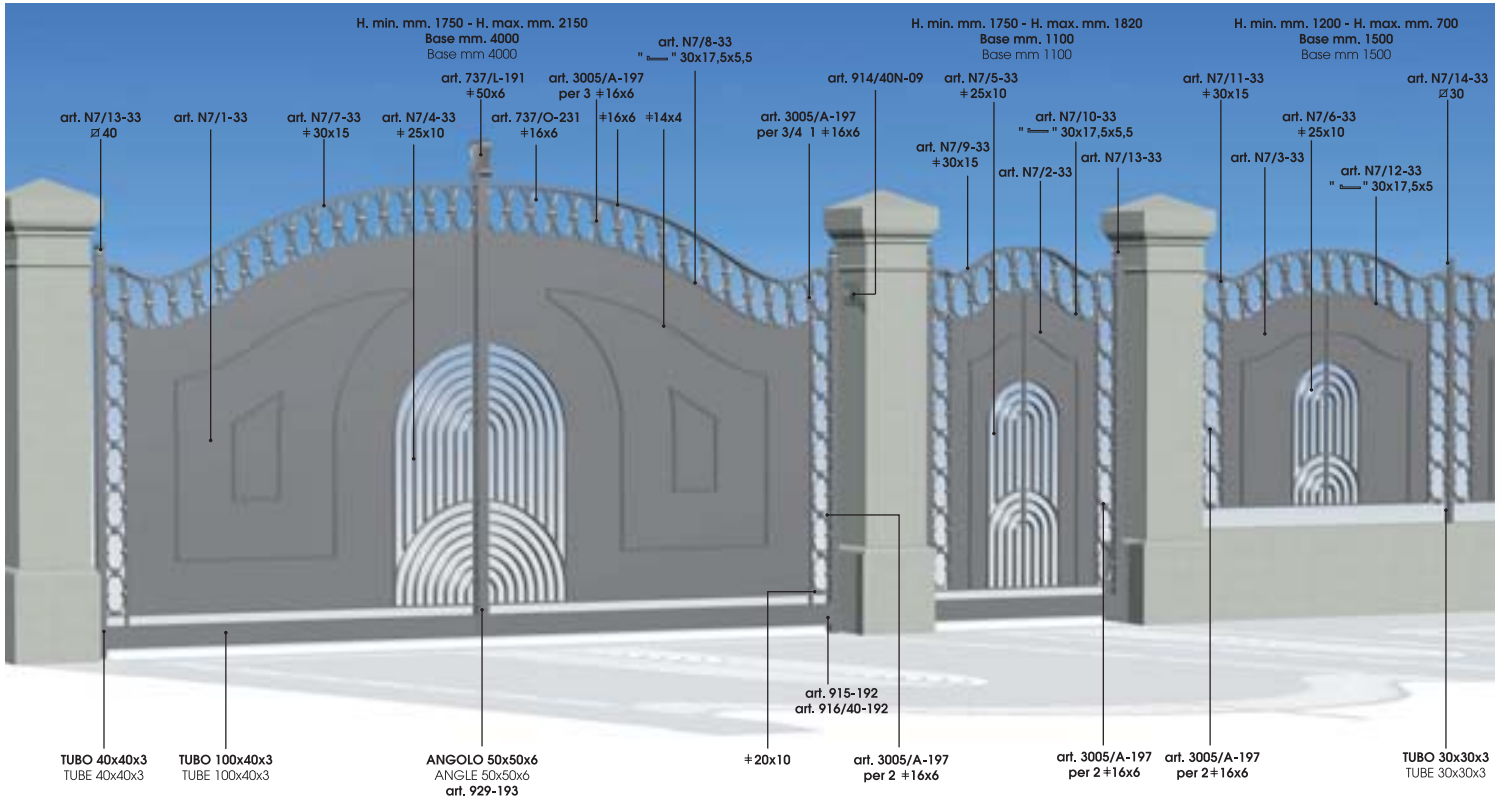

**VARIANTE "A" CANCELLATA 7**  
VERSION "A" OF GATE 7



**COMPONENTI PER CANCELLATA 7**  
ELEMENTS FOR GATE 7

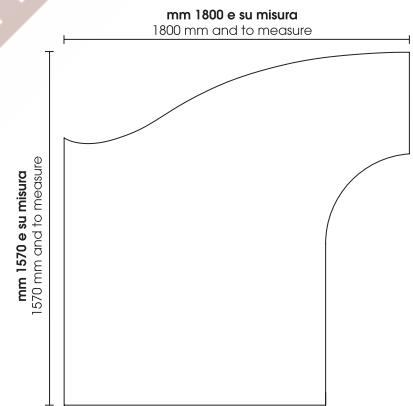

ART. N7/1-33  
lamiera spessore mm 4  
4 mm thick metal sheet

**VARIANTE "B" CANCELLATA 7**  
VERSION "B" OF GATE 7

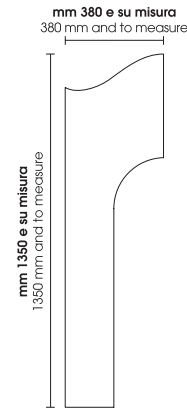

ART. N7/2-33  
lamiera spessore mm 4  
4 mm thick metal sheet

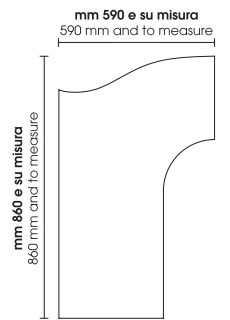

ART. N7/3-33  
lamiera spessore mm 4  
4 mm thick metal sheet



ART. 734-200  
# 50 # 16x6

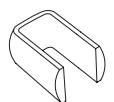

ART. 3005/A-197  
per 3 # 16x6

**COMPONENTI PER CANCELLATA 7**  
ELEMENTS FOR GATE 7



**ART. 3005/A-197**  
per 3/4 1 # 16x6

**ART. 734/O-231**  
# 16x6

**ART. 3005/A-197**  
per 2 # 16x6

**ART. N7/7-33**  
# 30x15

**ART. N7/8-33**  
" 30x17,5x5,5

**ART. N7/11-33**  
# 30x15

**ART. N7/12-33**  
" 30x17,5x5,5

**ART. N7/9-33**  
# 30x15

**ART. N7/10-33**  
" 30x17,5x5,5

**ART. N7/4-33**  
# 25x10

**ART. N7/5-33**  
# 25x10

**ART. N7/6-33**  
# 25x10

**ART. 914/40N-09**

**ART. 915-192**

**ART. 916/40-192**

# 16x6	<b>TUBO</b>	<b>TUBO</b>	<b>TUBO</b>	<b>TUBO</b>	<b>ANGOLO</b>	" "	" "	<b>ART. 929-193</b>	<b>ART. 737/L-191</b>	<b>ART. N7/13-33</b>	<b>ART. N7/14-33</b>
	TUBE	TUBE	TUBE	TUBE	ANGLE	30x17,5x5,5	# 20x10	# 14x4	# 50x6	Ø40	Ø30
	40x40x3	30x30x3	100x40x3	50x50x6							

**CANCELLATA 8**  
**GATE 8**

H. min. mm. 1585 - H. max. mm. 2280  
Base mm. 3325  
Base mm. 3325

H. min. mm. 1585 - H. max. mm. 1750  
Base mm. 1100  
Base mm. 1100

H. min. mm. 1030 - H. max. mm. 1280  
Base mm. 1500  
Base mm. 1500

**TUBO 40x40x3**  
TUBE 40x40x3

**art. N8/9-37**

**art. N8/8-37**

**art. N8/4-37**

**art. 912/50-191**

**art. 912/40-191**

**art. 914/40N-09**

**art. N8/6-37**

**art. N8/8-37**

**art. N8/5-37**

**art. 912/30-191**

**art. N8/1-37**

**art. N1/5-09**

**TUBO 40x40x3**  
TUBE 40x40x3

**" 50x50x6**  
**art. 929-193**

**art. 915-192**

**art. 916/40-192**

**art. N8/2-37**

**art. N1/5-09**

**art. N1/5-09**

**TUBO 30x30x3**  
TUBE 30x30x3

**art. N8/3-37**

**TUBO 30x30x3**  
TUBE 30x30x3

**VARIANTE "A" CANCELLATA 8**  
VERSION "A" OF GATE 8



**VARIANTE "B" CANCELLATA 8**  
VERSION "B" OF GATE 8



**COMPONENTI PER CANCELLATA 8**  
ELEMENTS FOR GATE 8

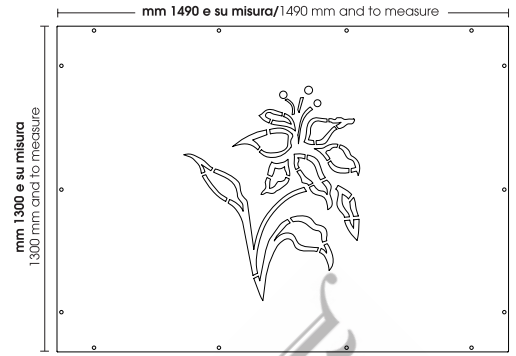

ART. N8/1-37  
lamiera spessore mm 4  
4 mm thick metal sheet

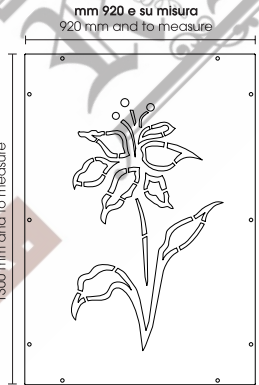

ART. N8/2-37  
lamiera spessore mm 4  
4 mm thick metal sheet

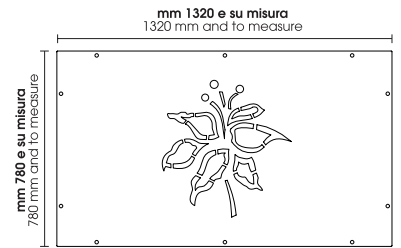

ART. N8/3-37  
lamiera spessore mm 4  
4 mm thick metal sheet

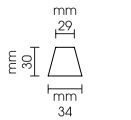

ART. N8/9-37  
inox AISI 316  
AISI 316 stainless steel

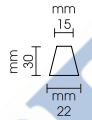

ART. N8/8-37  
inox AISI 316  
AISI 316 stainless steel

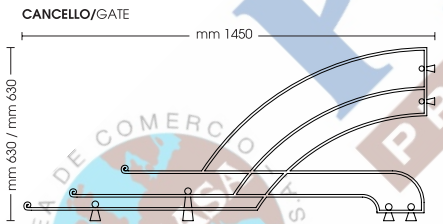

ART. N8/4-37  
# 30x10  
attacchi inox AISI 316/AISI 316 stainless steel connections  
sfere in ottone verniciato/painted brass balls

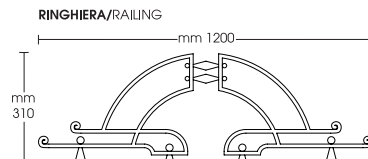

ART. N8/5-37  
# 30x10  
attacchi inox AISI 316/AISI 316 stainless steel connections  
sfere in ottone verniciato/painted brass balls

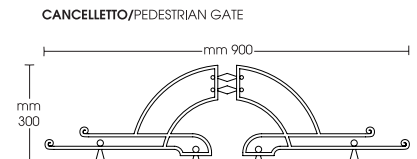

ART. N8/6-37  
# 30x10  
attacchi inox AISI 316/AISI 316 stainless steel connections  
sfere in ottone verniciato/painted brass balls

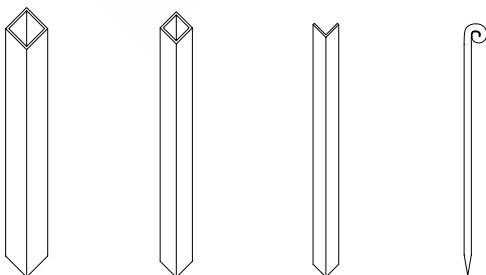

TUBO TUBO ANGOLO ART. 929-193  
TUBE TUBE ANGLE  
40x40x3 30x30x3 50x50x6

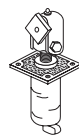

ART. 914/40N-09



ART. 916/40-192



ART. 922-193



ART. 922/A-193



ART. N1/5-09  
inox AISI 316  
AISI 316 stainless steel

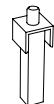

ART. 915-192



ART. 3035-194



ART. 912/50-191  
# 50x50



ART. 912/40-191  
# 40x40



ART. 912/30-191  
# 30x30

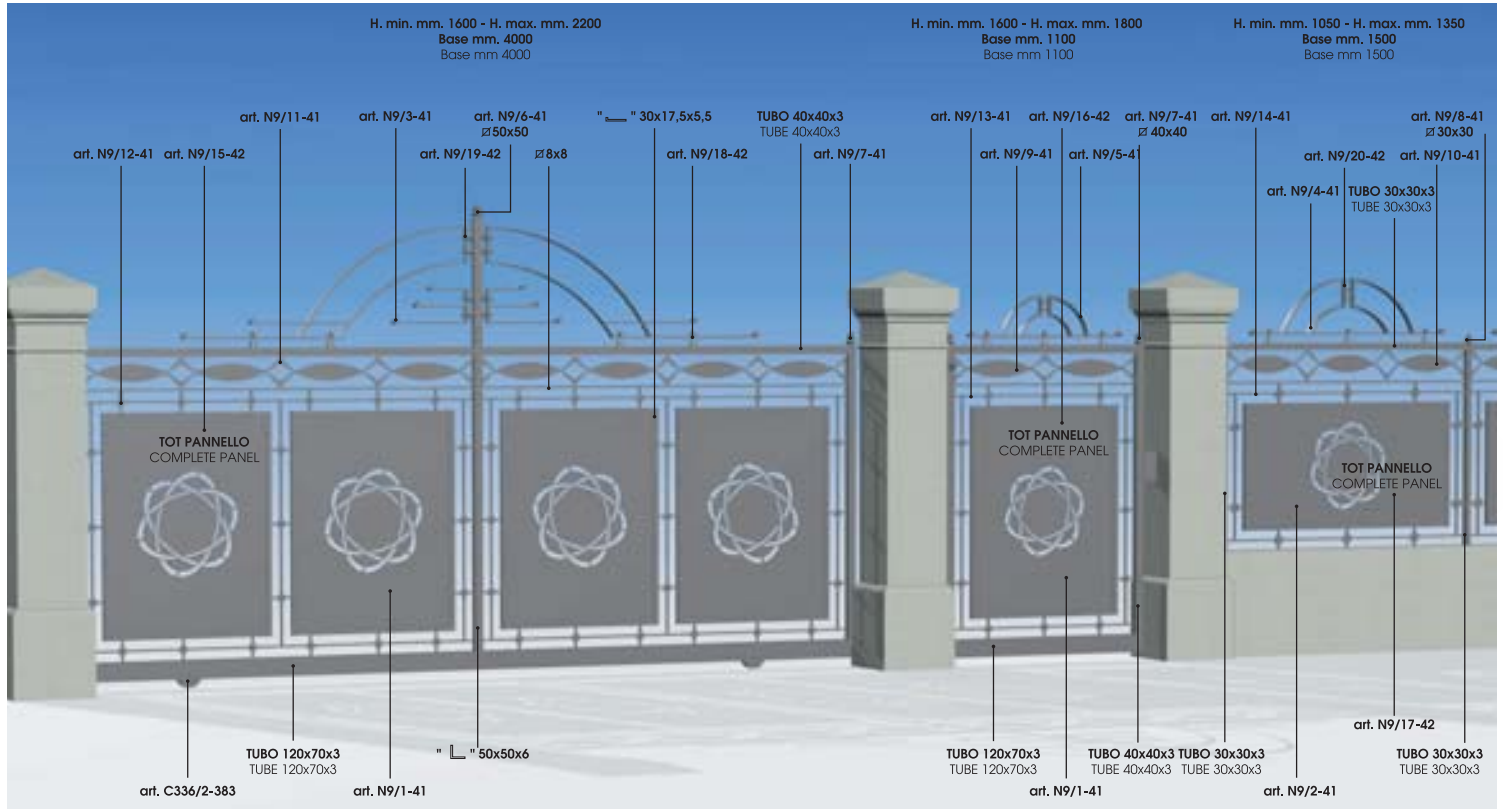

**VARIANTE "A" CANCELLATA 9**  
VERSION "A" OF GATE 9



**VARIANTE "B" CANCELLATA 9**  
VERSION "B" OF GATE 9



**COMPONENTI PER CANCELLATA 9**  
ELEMENTS FOR GATE 9

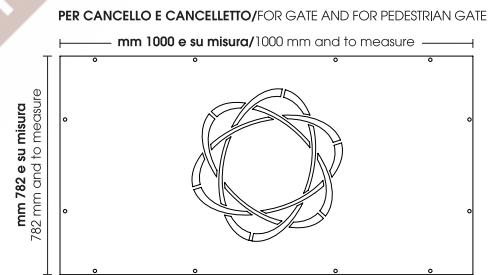

ART. N9/1-41  
lamiera spessore mm 4  
4 mm thick metal sheet

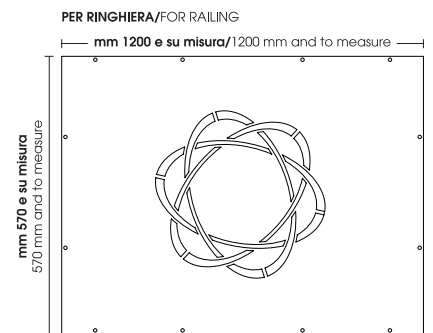

ART. N9/2-41  
lamiera spessore mm 4  
4 mm thick metal sheet

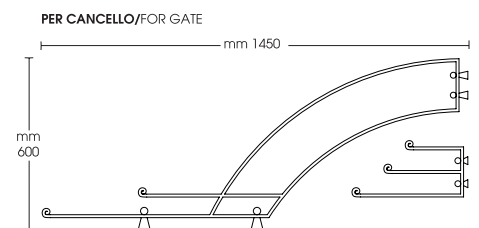

ART. N9/3-41  
∅ 30x10  
attacchi in inox AISI 316  
AISI 316 stainless steel connections  
sfere in ottone verniciato  
painted brass balls

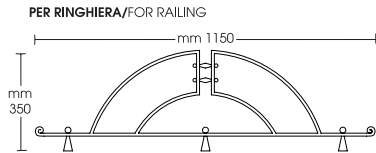

**ART. N9/4-41**  
# 30x10  
attacchi in inox AISI 316  
AISI 316 stainless steel connections  
sfere in ottone verniciato  
painted brass balls

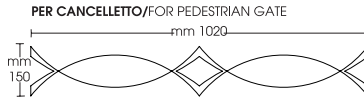

**ART. N9/9-41**  
lamiera spessore mm 8  
8 mm thick metal sheet



**ART. N9/6-41**  
#50x50



**ART. N9/7-41**  
#40x40



**ART. N9/8-41**  
#30x30

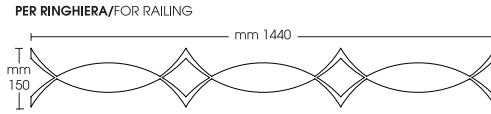

**ART. N9/10-41**  
lamiera spessore mm 8  
8 mm thick metal sheet

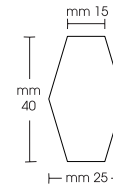

**ART. N9/20-42**

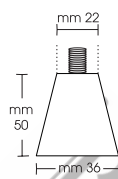

**ART. N9/18-42**  
inox AISI 316

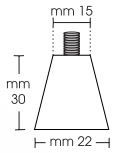

**ART. N9/19-42**  
inox AISI 316

AISI 316 stainless steel AISI 316 stainless steel

PER CANCELLETO/FOR PEDESTRIAN GATE

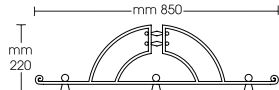

**ART. N9/5-41**  
# 30x10  
attacchi in inox AISI 316  
AISI 316 stainless steel connections  
sfere in ottone verniciato  
painted brass balls

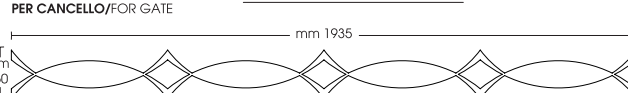

**ART. N9/11-41**  
lamiera spessore mm 8  
8 mm thick metal sheet

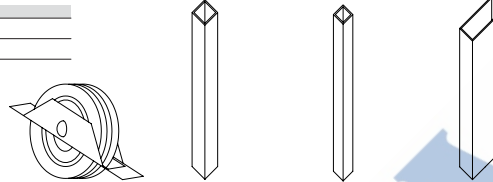

ART. C336/2-383	TUBO	TUBO	TUBO	TUBO	ANGOLO	" "	PIENO
	TUBE	TUBE	TUBE	TUBE	ANGLE		SOLID
	40x40x3	30x30x3	120x70x3		50x50x6	30x17.5x5.5	Ø8x8

PER CANCELLO/FOR GATE

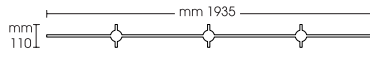

**ART. N9/12-41**  
lamiera spessore mm 8  
8 mm thick metal sheet

PER CANCELLETO/FOR PEDESTRIAN GATE

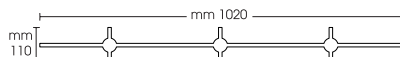

**ART. N9/13-41**  
lamiera spessore mm 8  
8 mm thick metal sheet

PER RINGHIERA/FOR RAILING

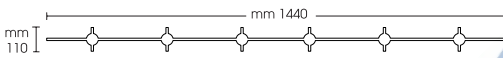

**ART. N9/14-41**  
lamiera spessore mm 8  
8 mm thick metal sheet

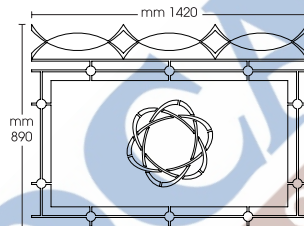

**ART. N9/17-42**  
lamiera spessore mm 4  
4 mm thick metal sheet

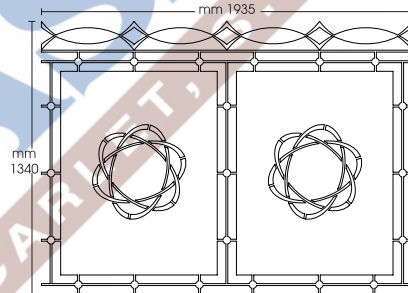

**ART. N9/15-42**  
lamiera spessore mm 4  
4 mm thick metal sheet

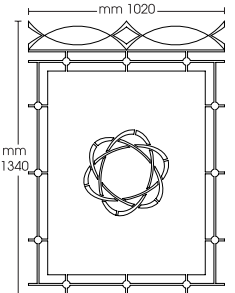

**ART. N9/16-42**  
lamiera spessore mm 4  
4 mm thick metal sheet

**SOLUZIONE GLOBALE (CON LAMIERE E CORNICI FORATE INSIEME) PER CANCELLATA 9**  
COMPLETE SOLUTION (WITH METAL SHEETS AND FRAMES CUT TOGETHER) FOR GATE 9

**CANCELLATA 10**  
GATE 10

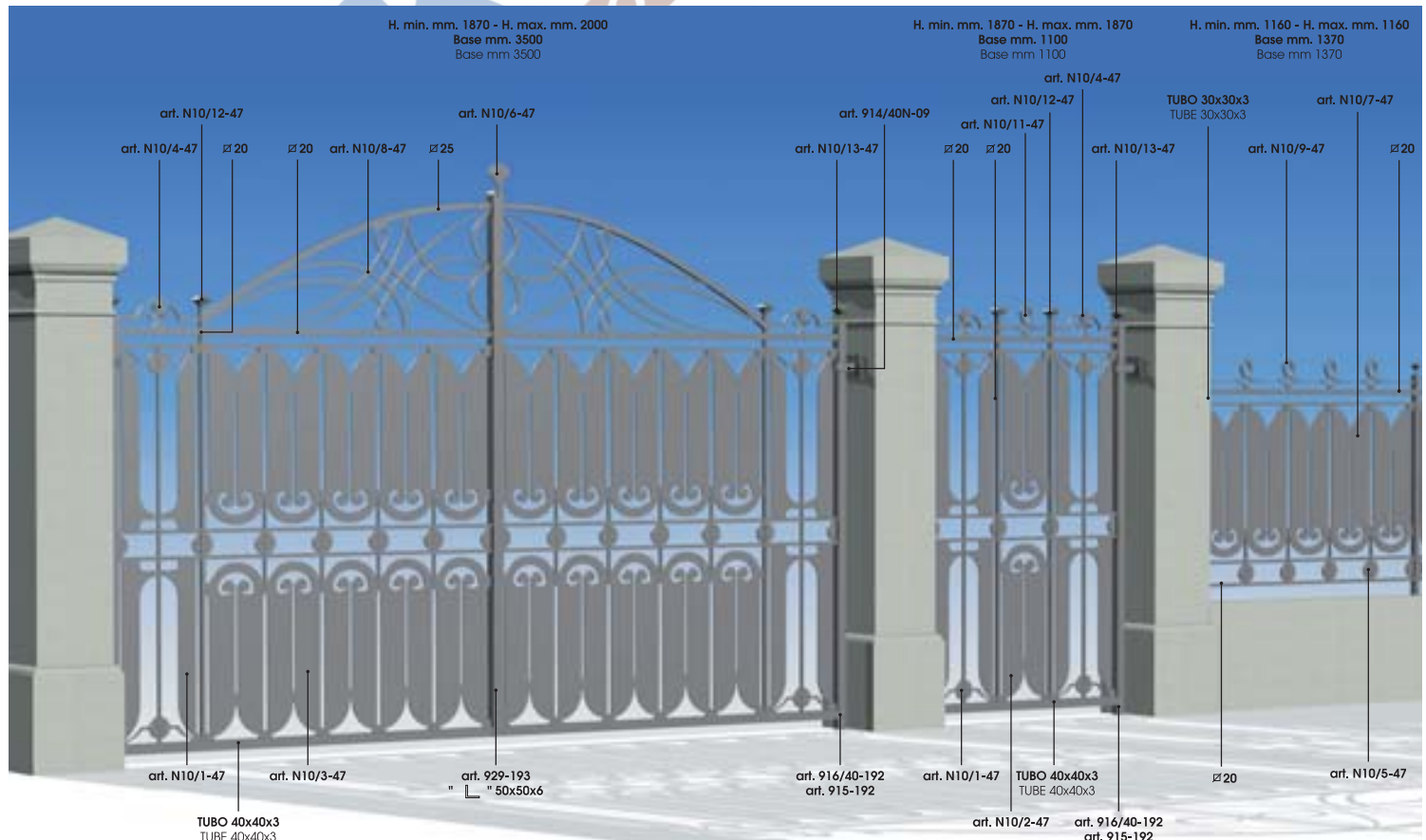

**VARIANTE "A" CANCELLATA 10**  
VERSION "A" OF GATE 10

**COMPONENTI PER CANCELLATA 10**  
ELEMENTS FOR GATE 10

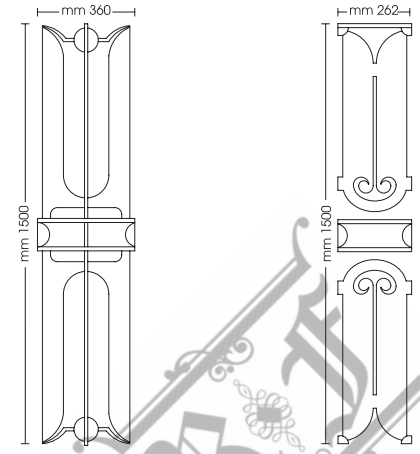

ART. N10/1-47  
lamiera spessore mm 4  
4 mm thick metal sheet

ART. N10/2-47  
lamiera spessore mm 4  
4 mm thick metal sheet

**VARIANTE "B" CANCELLATA 10**  
VERSION "B" OF GATE 10

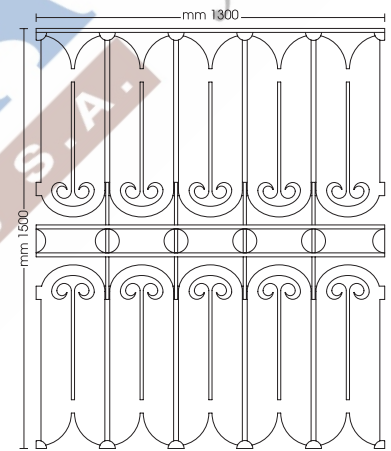
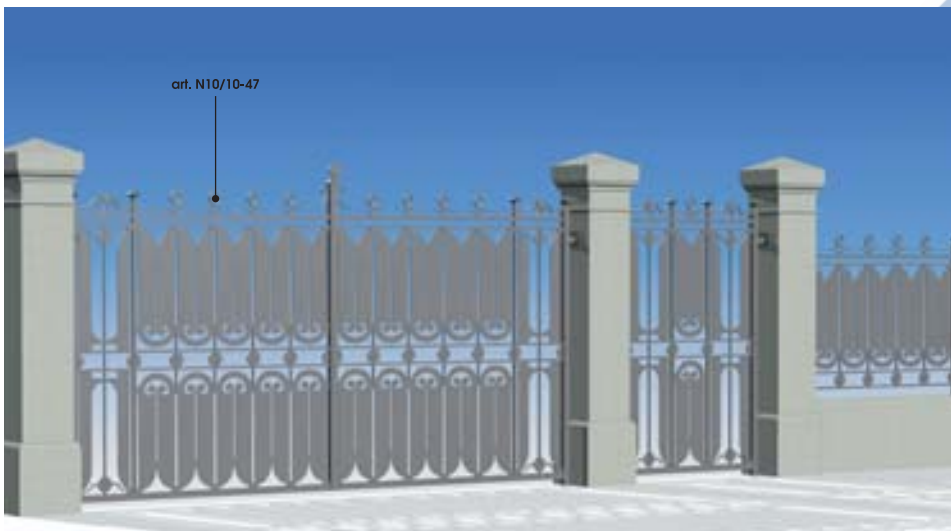

ART. N10/3-47  
lamiera spessore mm 4  
4 mm thick metal sheet

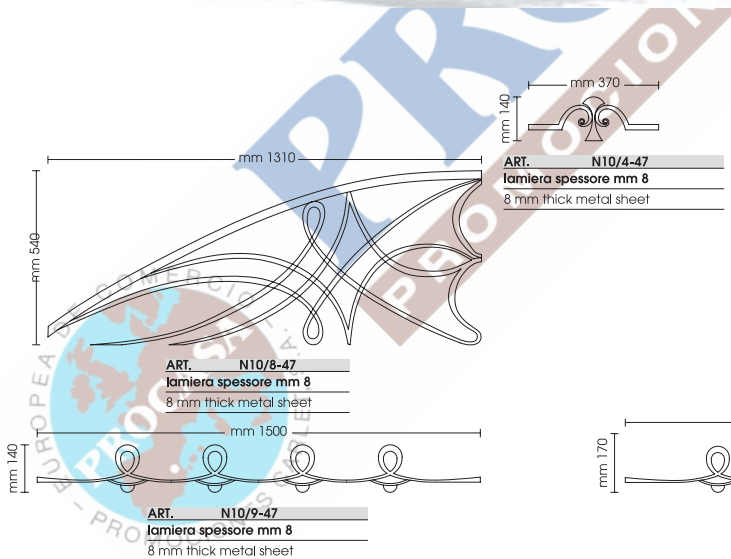

ART. N10/4-47  
lamiera spessore mm 8  
8 mm thick metal sheet

ART. N10/6-47  
lamiera spessore mm 8  
8 mm thick metal sheet

ART. N10/8-47  
lamiera spessore mm 8  
8 mm thick metal sheet

ART. N10/5-47  
Ø 90 mm spessore mm 4  
Ø 90 mm, 4 mm thick

ART. N10/9-47  
lamiera spessore mm 8  
8 mm thick metal sheet

ART. N10/10-47  
lamiera spessore mm 8  
8 mm thick metal sheet

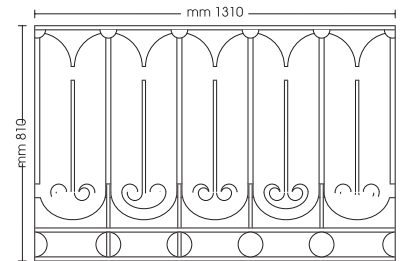

ART. N10/7-47  
lamiera spessore mm 4  
4 mm thick metal sheet

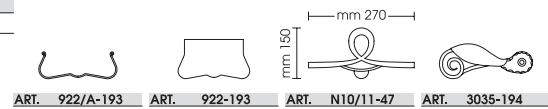









ART. 922/A-193

ART. 922-193

ART. N10/11-47

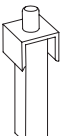
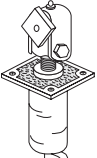
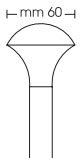
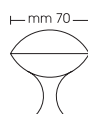
ART. 3035-194

										
TUBO	TUBO	ANGOLO	SOLID	PIENO	QUADRO PIENO	ART. 915-192	ART. 914/40N-09	ART. N10/12-47	ART. N10/13-47	ART. 916/40-192
Ø 40x40x3	Ø 30x30x3	50x50x6	Ø 20		SOLID SQUARE Ø 25					

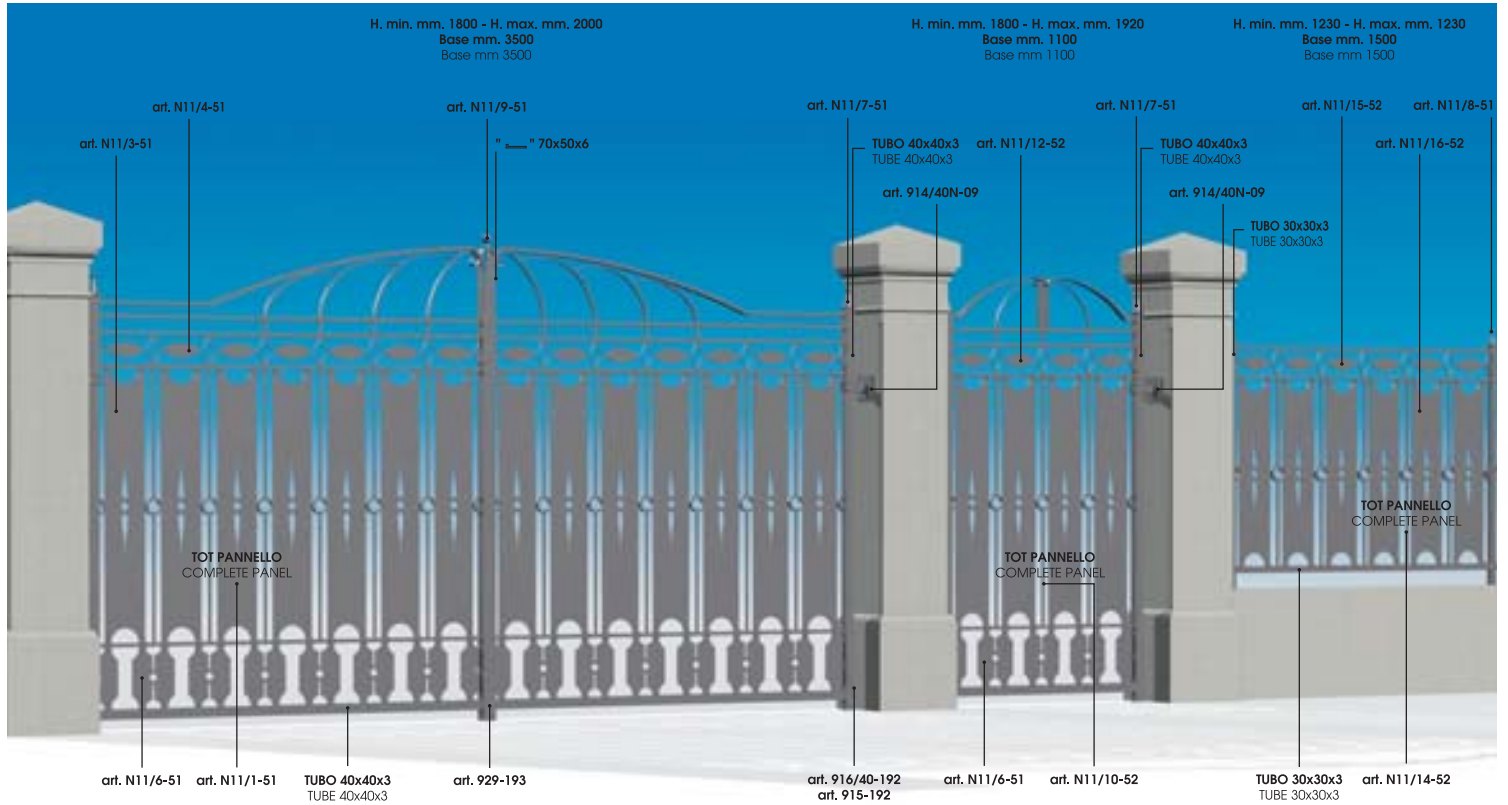

**VARIANTE "A" CANCELLATA 11**  
VERSION "A" OF GATE 11

**COMPONENTI PER CANCELLATA 11**  
ELEMENTS FOR GATE 11

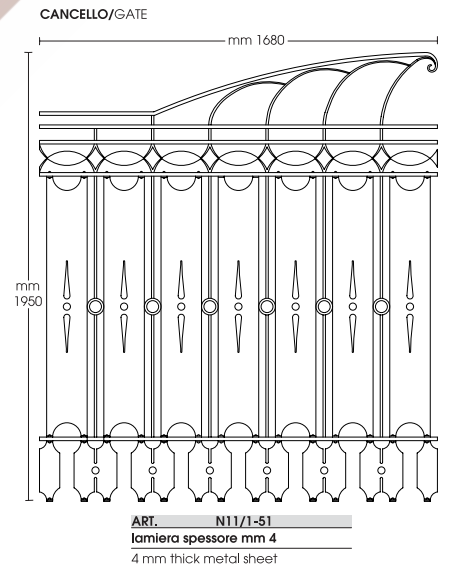

**VARIANTE "B" CANCELLATA 11**  
VERSION "B" OF GATE 11

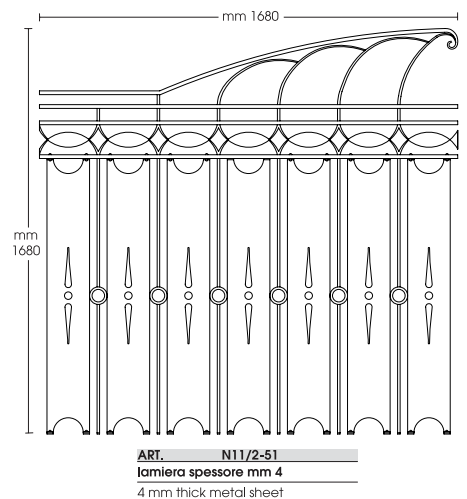
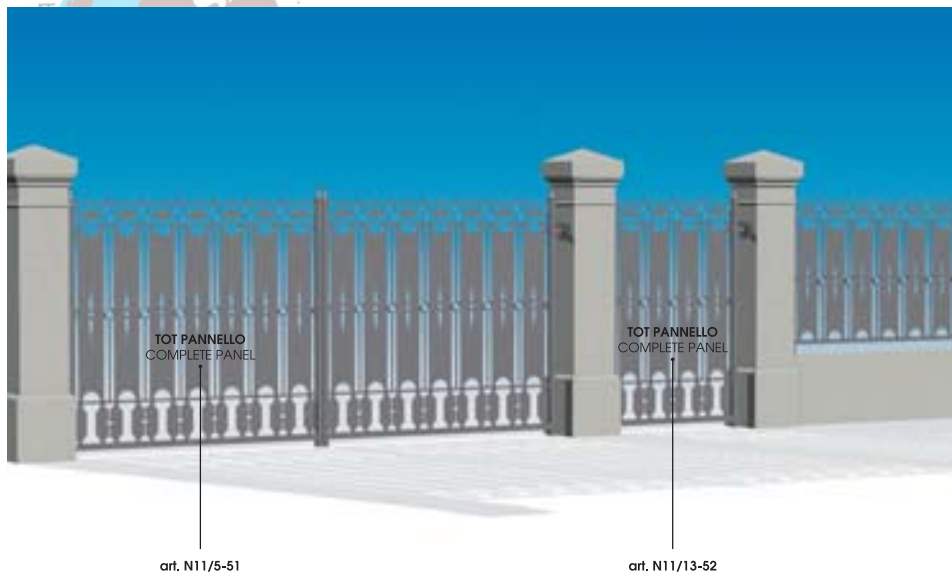



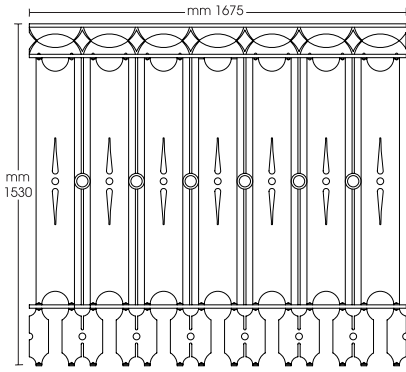

**ART. N11/5-51**  
lamiera spessore mm 4  
4 mm thick metal sheet

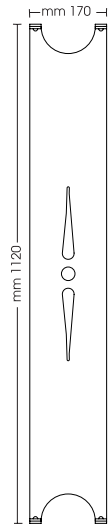

**ART. N11/3-51**  
lamiera spessore mm 4  
4 mm thick metal sheet

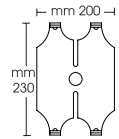

**ART. N11/6-51**  
lamiera spessore mm 4  
4 mm thick metal sheet

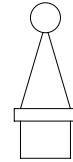

**ART. N11/7-51**  
ø40

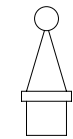

**ART. N11/8-51**  
ø30

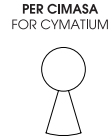

PER CIMASA  
FOR CYMATIUM

**ART. N11/9-51**



**ART. 3035-194**

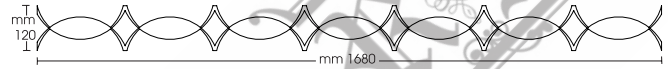

**ART. N11/4-51**  
lamiera spessore mm 8  
8 mm thick metal sheet

**RINGHIERA/RAILING**

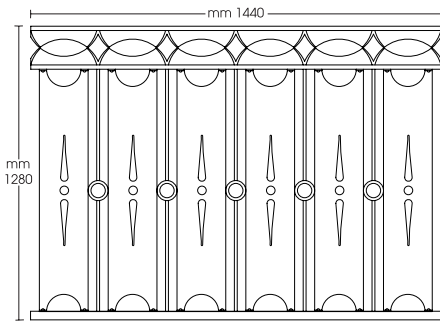

**ART. N11/14-52**  
lamiera spessore mm 4  
4 mm thick metal sheet

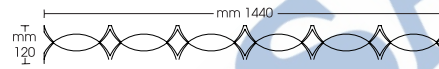

**ART. N11/15-52**  
lamiera spessore mm 8  
8 mm thick metal sheet

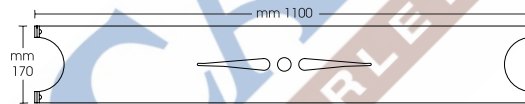

**ART. N11/16-52**  
lamiera spessore mm 4  
4 mm thick metal sheet

**CANCELLETTO/PEDESTRIAN GATE**

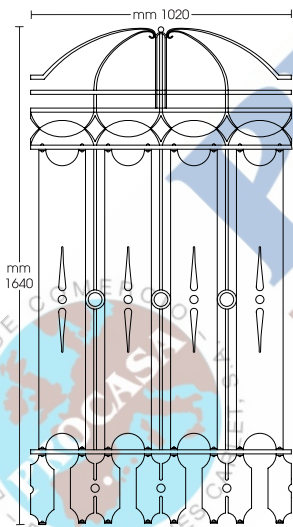

**ART. N11/10-52**  
lamiera spessore mm 4  
4 mm thick metal sheet

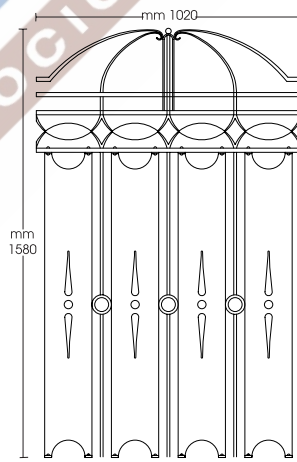

**ART. N11/11-52**  
lamiera spessore mm 4  
4 mm thick metal sheet

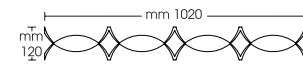

**ART. N11/12-52**  
lamiera spessore mm 8  
8 mm thick metal sheet

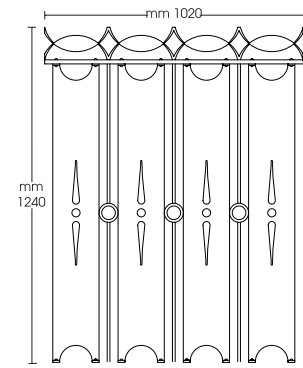

**ART. N11/13-52**  
lamiera spessore mm 4  
4 mm thick metal sheet

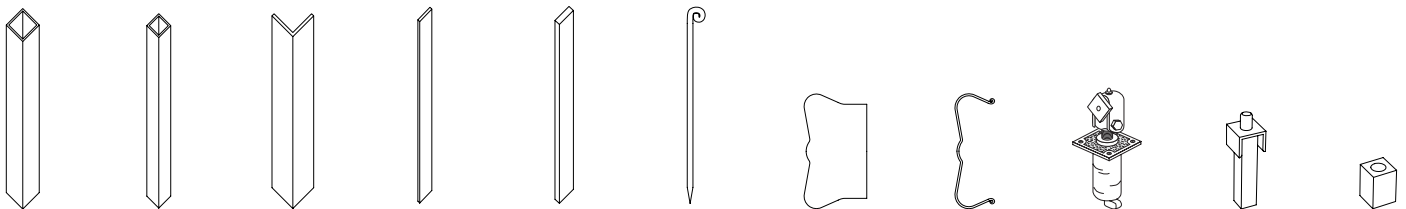

<b>TUBO</b>	<b>TUBO</b>	"E"			<b>ART. 929-193</b>	<b>ART. 922-193</b>	<b>ART. 922/A-193</b>	<b>ART. 914/40N-09</b>	<b>ART. 915-192</b>	<b>ART. 916/40-192</b>
TUBE	TUBE	70x50x6	±25x8	±30x15						
40x40x3	30x30x3									

**COMPONENTI PER POGGIOLO 1**  
ELEMENTS FOR BALCONY 1

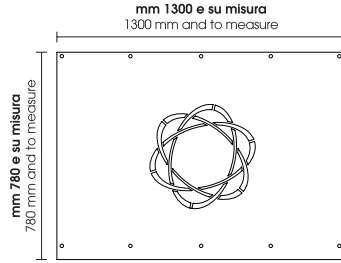

ART. N50/1-54

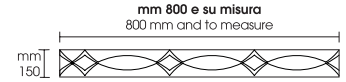

ART. N50/4-54  
spessore mm 5  
5 mm thick

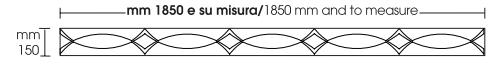

ART. N50/3-54  
spessore mm 8  
8 mm thick

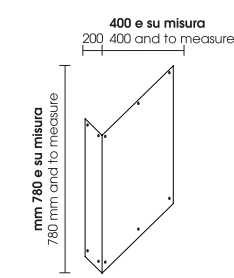

ART. N50/2-54  
spessore mm 12  
12 mm thick

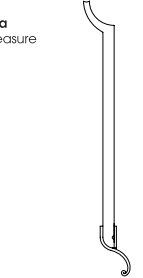

ART. N50/5-54  
spessore mm 12  
12 mm thick



TUBO  
30x20x3



TUBO  
Ø42,4x3



ART. N50/6-54  
Ø100x8

**COMPONENTI PER POGGIOLO 2**  
ELEMENTS FOR BALCONY 2

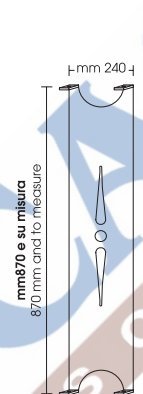

ART. N51/1-55  
lamiera spessore mm 4  
4 mm thick metal sheet

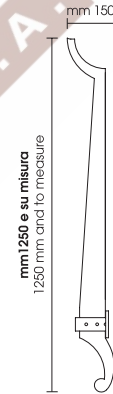

ART. N51/2-55  
lamiera spessore mm 4  
4 mm thick metal sheet

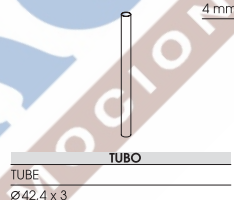

TUBO  
Ø42,4 x 3

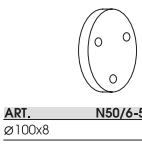

ART. N50/6-54  
Ø100x8

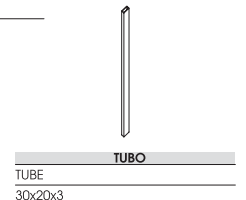

TUBO  
30x20x3

**COMPONENTI PER POGGIOLO 3**  
ELEMENTS FOR BALCONY 3

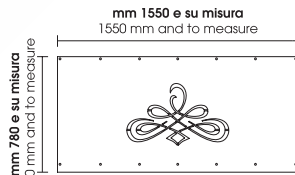

ART. N52/1-56  
lamiera spessore mm 4  
4 mm thick metal sheet

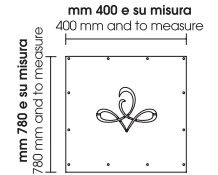

ART. N52/2-56  
lamiera spessore mm 4  
4 mm thick metal sheet

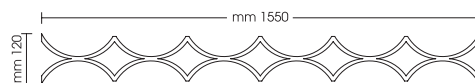

ART. N52/3-56  
lamiera spessore mm 8  
8 mm thick metal sheet

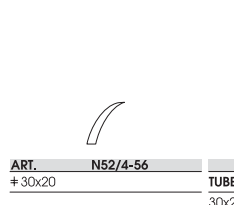

ART. N52/4-56  
# 30x20

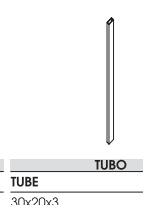

TUBO  
30x20x3

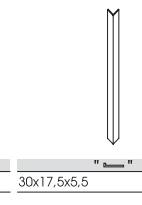

TUBO  
30x17,5x5,5



TUBO  
Ø42,4x3



ART. N50/6-54  
Ø100x8

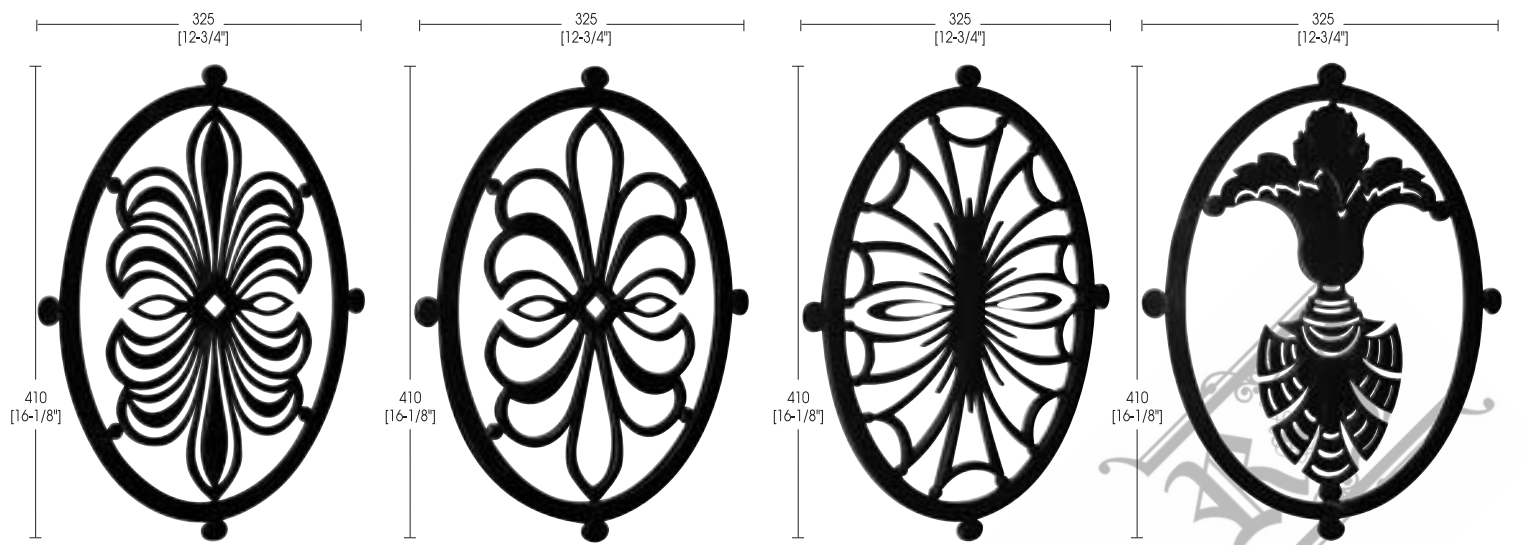

ART.	N 57/01	N 57/02	N 57/03	N 57/04
ALTEZZA mm HEIGHT	410	410	410	410
LARGHEZZA mm WIDTH	325	325	325	325

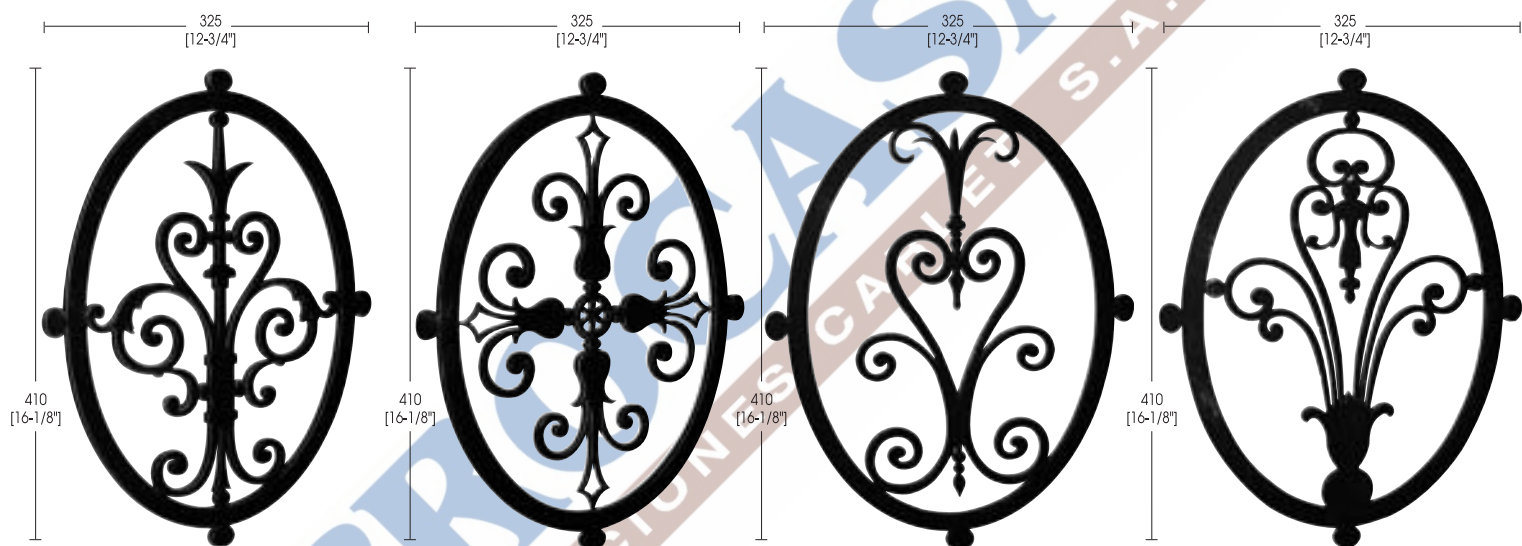

ART.	N 57/05	N 57/06	N 57/07	N 57/08
ALTEZZA mm HEIGHT	410	410	410	410
LARGHEZZA mm WIDTH	325	325	325	325

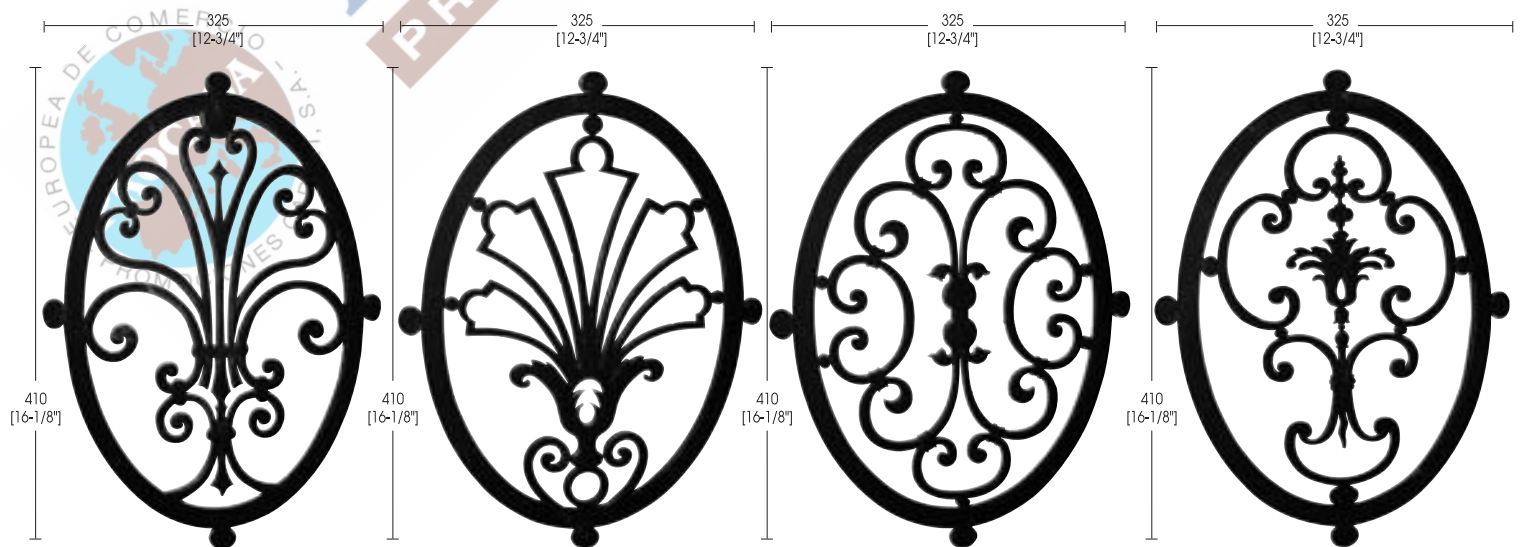

ART.	N 57/09	N 57/10	N 57/11	N 57/12
ALTEZZA mm HEIGHT	410	410	410	410
LARGHEZZA mm WIDTH	325	325	325	325



ART. N 57/13

Ricavato da ART. 5-509/001 vedi pag. 104.  
Obtained with Art. 5-509/001 see page 104

Ricavato da D/3 vedi pag. 100  
Obtained with Art. D/3 see page 100



ART. N 57/15

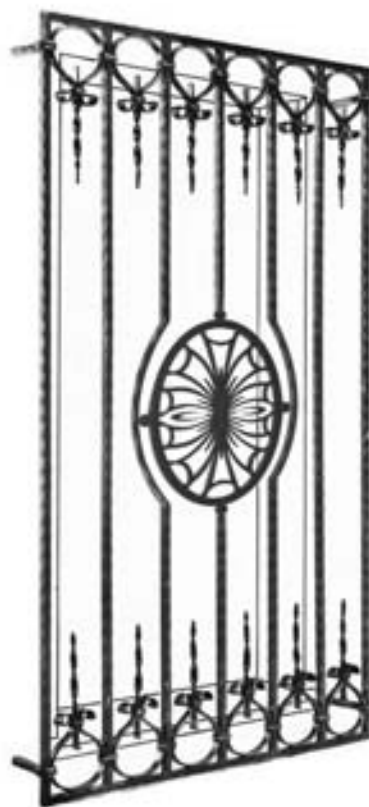

ART. N 57/16

ART.	N 57/14
ALTEZZA mm	1000
HEIGHT	
LARGHEZZA mm	100
WIDTH	
SEZIONE mm	∅ 12-14-16
SECTION	
Kg.	-

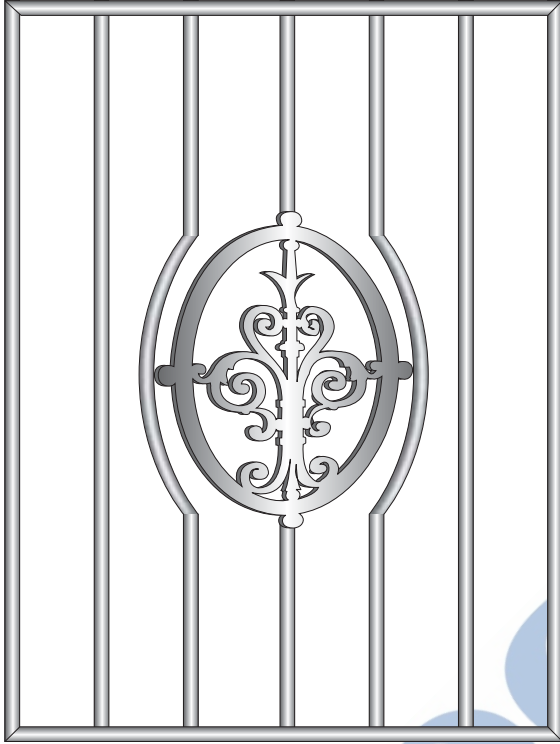

ART. N 57/17

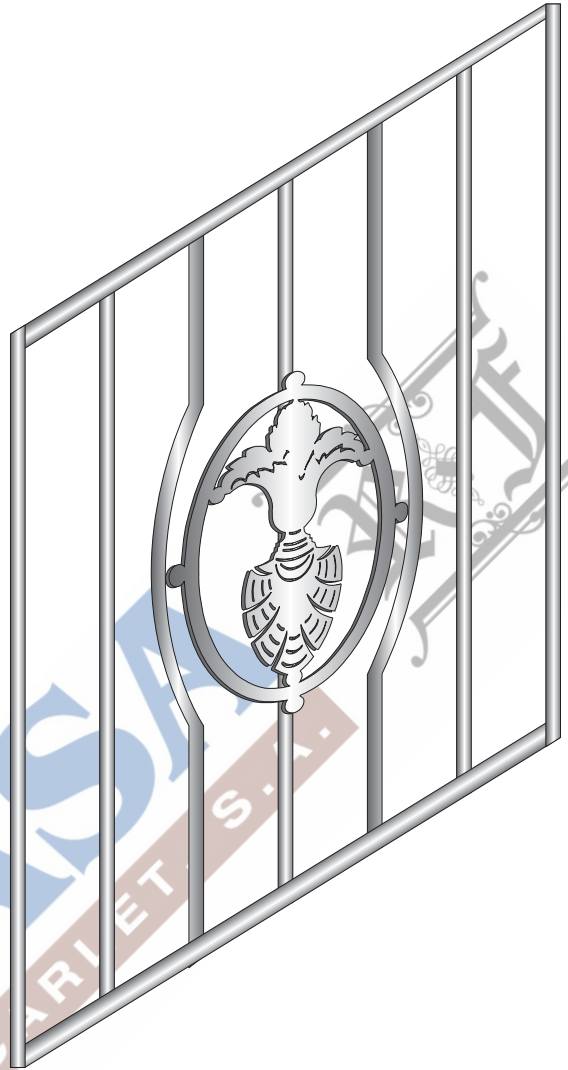

ART. N 57/18

**MEZZI MOTIVI PER COMPORRE A PIACIMENTO CANCELLI, RINGHIERE E INFERRIATE**  
**HALF-MOTIFS TO USE ON GATES, RAILINGS AND GRATES**

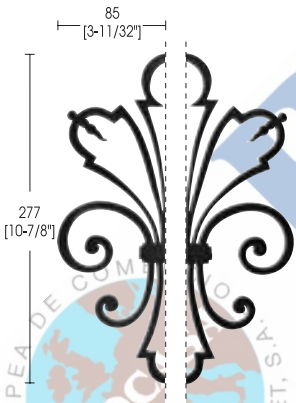

ART. N 57/19  
 SPESSORE mm THICKNESS 8

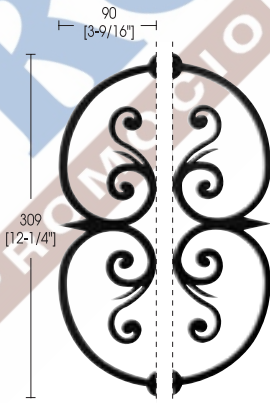

ART. N 57/20  
 SPESSORE mm THICKNESS 8

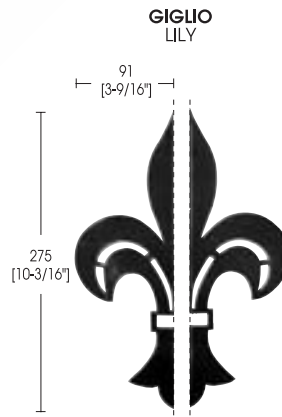

ART. N 57/21  
 SPESSORE mm THICKNESS 8

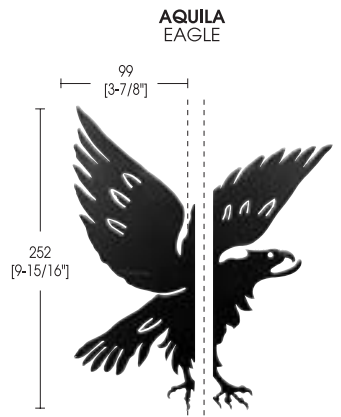

ART. N 57/22  
 SPESSORE mm THICKNESS 8

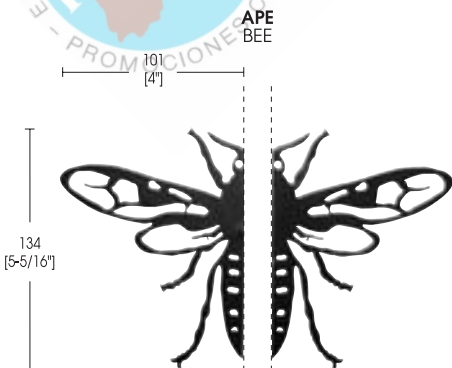

ART. N 57/23  
 SPESSORE mm THICKNESS 8

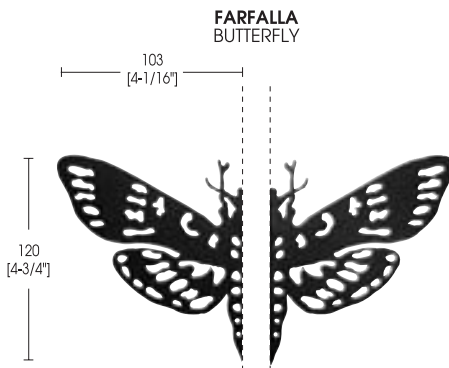

ART. N 57/24  
 SPESSORE mm THICKNESS 8

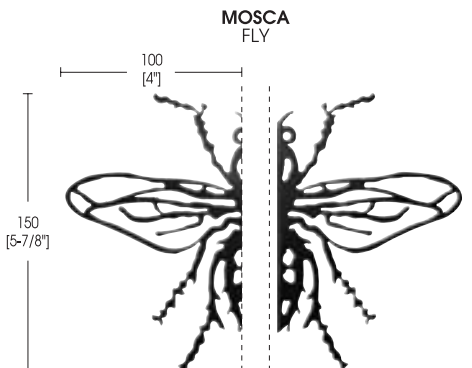

ART. N 57/25  
 SPESSORE mm THICKNESS 8

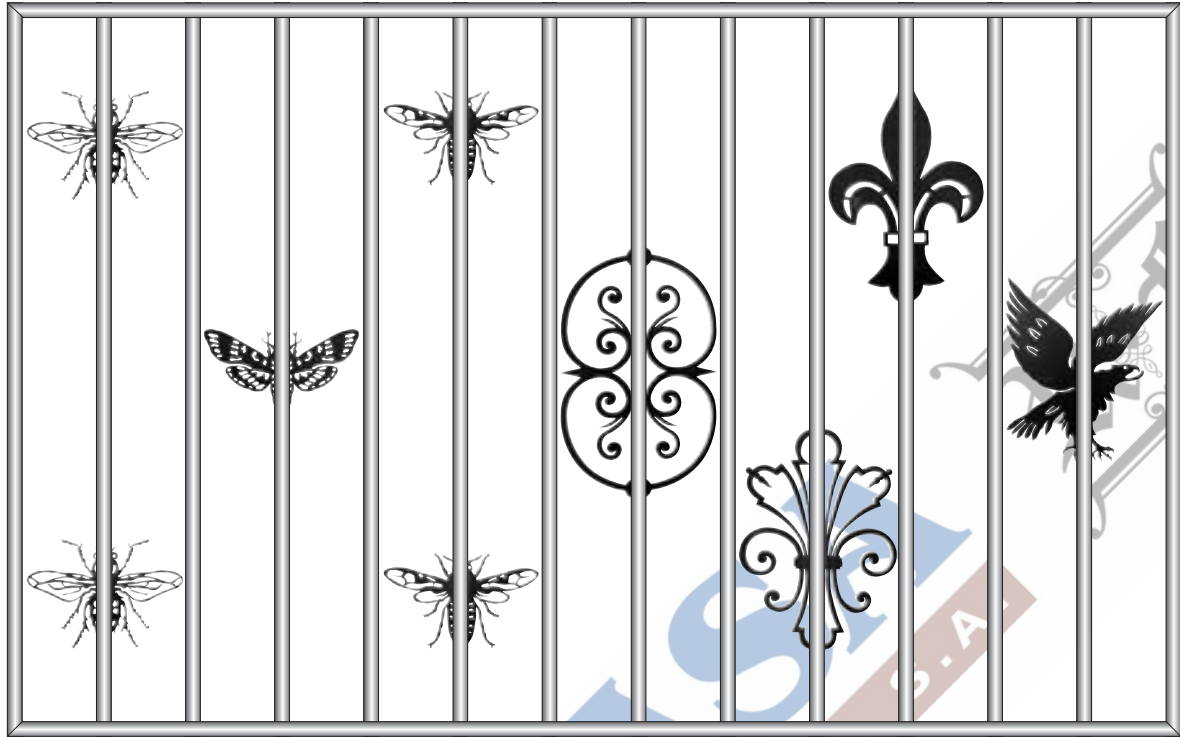

ART. N 57/26

PANNELLI IN LAMIERA PER COMPORRE "CANCELLI DI NUOVA GENERAZIONE", CON MISURE E SPESSORI SU RICHIESTA  
METAL-SHEET PANELS TO USE ON "GATES OF NEW GENERATION" WITH CUSTOMIZED SIZES AND THICKNESSES



ART. N 57/27



ART. N 57/28



ART. N 57/29



ART. N 57/30



ART. N 57/31

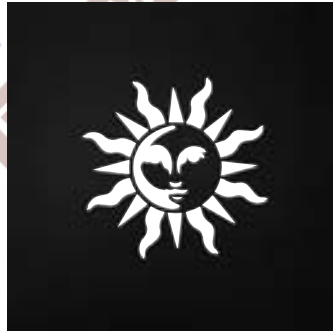

ART. N 57/32



ART. N 57/33



ART. N 57/34



ART. N 57/35



ART. N 57/36



ART. N 57/37



ART. N 57/38



ART. N 57/39



ART. N 57/40

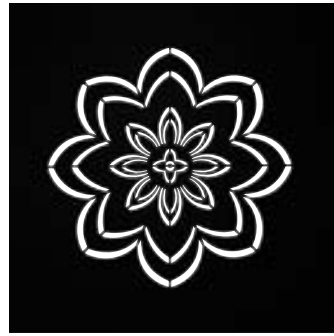

ART. N 57/41



ART. N 57/42



ART. N 57/43

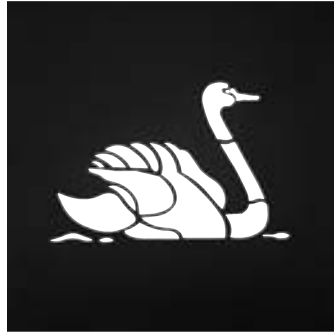

ART. N 57/44



ART. N 57/45



ART. N 57/46



ART. N 57/47



ART. N 57/48

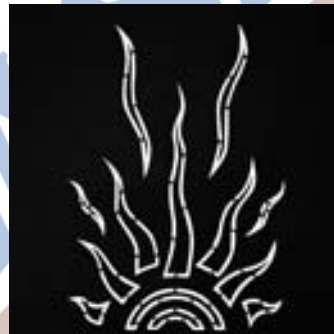

ART. N 57/49



ART. N 57/50

ESEMPI DI APPLICAZIONE DEI PANNELLI IN LAMIERA SOPRA  
APPLICATION EXAMPLES OF ABOVE METAL SHEET PANELS

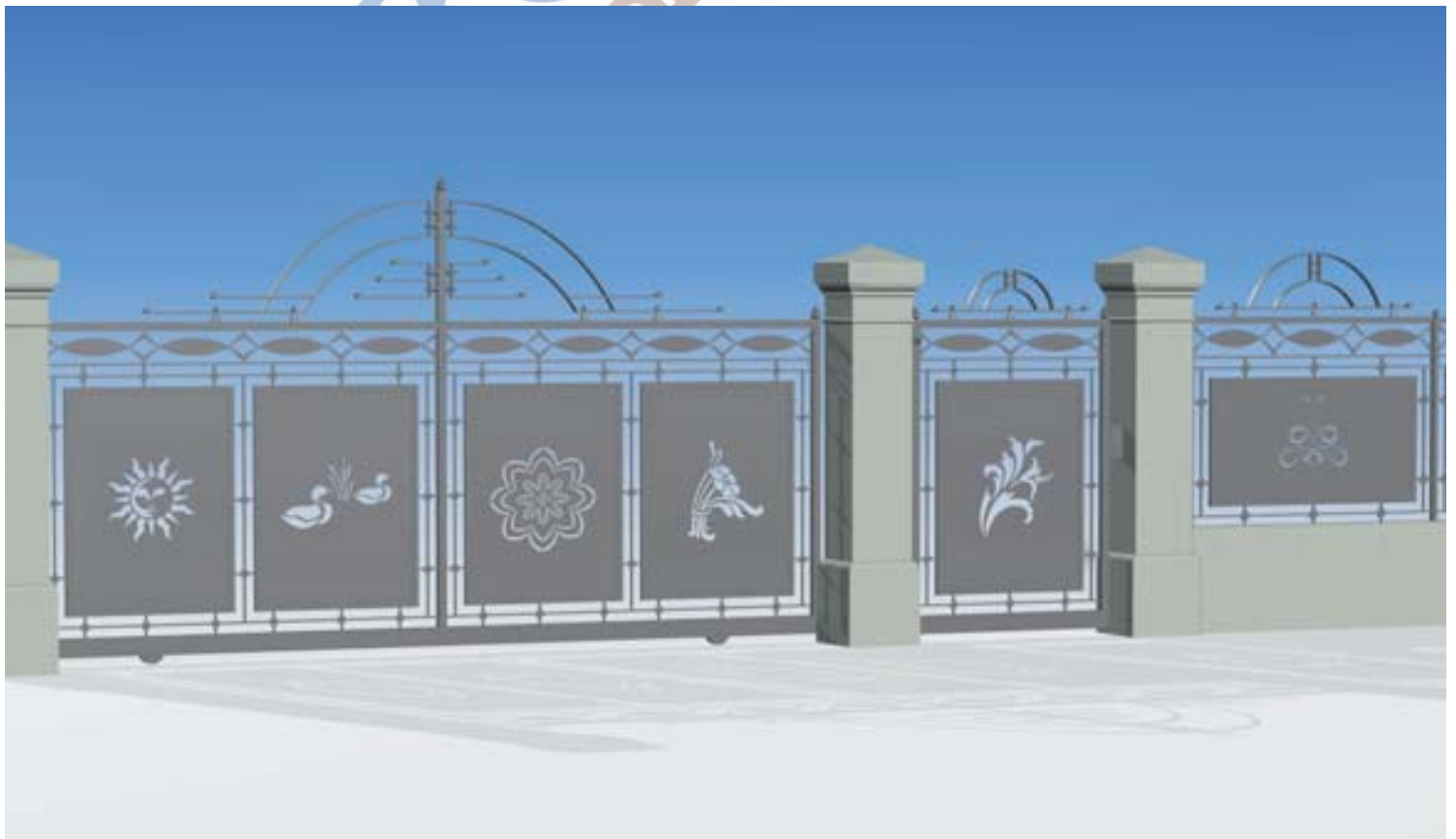



ART. CANCELLATA 9 VARIANTE B di pag. 131 / VERSION B OF GATE 9 ON PAGE 131



ART. CANCELLATA 8 VARIANTE A di pag. 130 / VERSION A OF GATE 8 ON PAGE 130

**ARTICOLI IN GRANITO DI PRIMA QUALITÀ, ETERNI, SCOLPITI A MANO**  
FIRST QUALITY GRANITE ITEMS, ETERNAL AND HAND CURVED

**COLONNA CON FORO CENTRALE Ø 160**  
per il riempimento con calcestruzzo  
COLUMN WITH Ø 160 mm HOLE  
to allow filling with concrete



ART.	G1
ALTEZZA mm HEIGHT	2110
LARGHEZZA mm WIDTH	100x650
Kg.	1100



ART.	G2
ALTEZZA mm HEIGHT	2300
LARGHEZZA mm WIDTH	500
Kg.	550

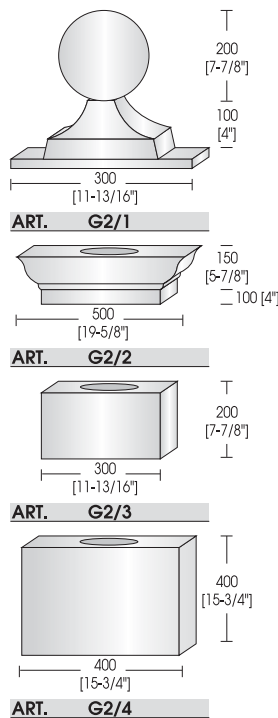

ART.	G3
ALTEZZA mm HEIGHT	1860
LARGHEZZA mm WIDTH	1200x650
Kg.	1066